

# Squeezed light, generation and applications.

Eugeniy E. Mikhailov

The College of William & Mary



April 30, 2010

# What is quantum optics

## Classical/Geometrical optics

- light is a ray
- which propagates straight
- cannot explain diffraction and interference

## Semiclassical optics

- light is a wave
- color (wavelength/frequency) is important
- amplitude ( $a$ ) and phase are important,  $E(t) = ae^{i(kz - \omega t)}$
- cannot explain residual measurements noise

## Quantum optics

- light consists of photons:  $N = a^\dagger a$
- detector measures quadratures:  $X_1 = (a^\dagger + a)/2$  and  $X_2 = i(a^\dagger - a)/2$
- amplitude and phase cannot be measured precisely:  
 $\langle \Delta X_1^2 \rangle \langle \Delta X_2^2 \rangle \geq 1/4$

# Classical field

$$E(\phi) = |a|e^{-i\phi} = |a|\cos(\phi) + i|a|\sin(\phi) = X_1 + iX_2, \quad \phi = \omega t - kz$$

Detectors sense the **real** part of the field ( $X_1$ ) but there is a way to see  $X_2$  as well

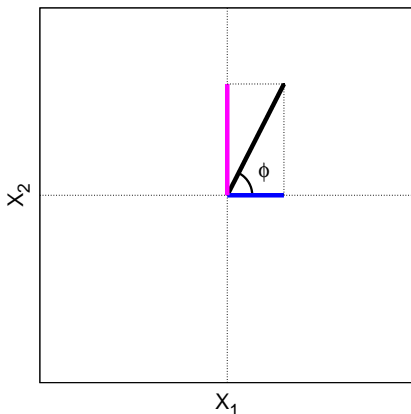

# Classical field

$$E(\phi) = |a|e^{-i\phi} = |a|\cos(\phi) + i|a|\sin(\phi) = X_1 + iX_2, \quad \phi = \omega t - kz$$

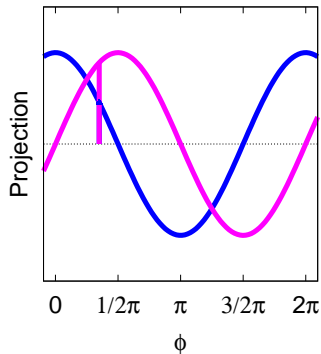
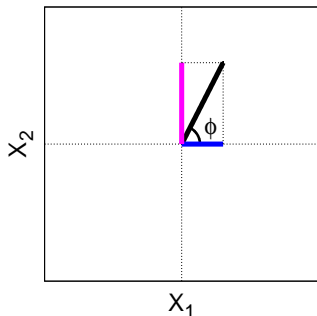

# Classical field

$$E(\phi) = |a|e^{-i\phi} = |a| \cos(\phi) + i|a| \sin(\phi) = X_1 + iX_2, \quad \phi = \omega t - kz$$

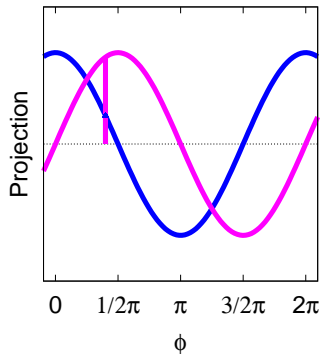
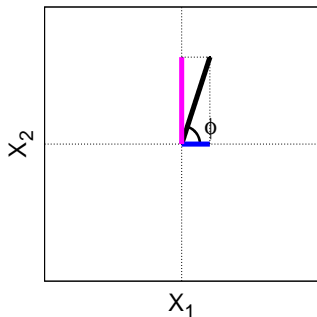

# Classical field

$$E(\phi) = |a|e^{-i\phi} = |a| \cos(\phi) + i|a| \sin(\phi) = X_1 + iX_2, \quad \phi = \omega t - kz$$

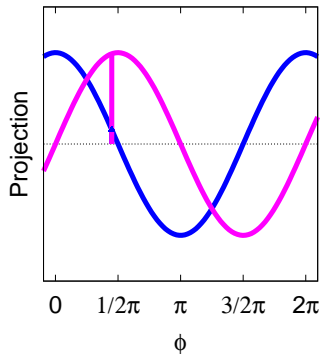
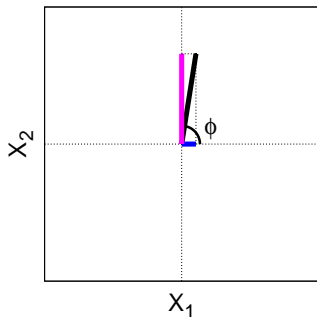

# Classical field

$$E(\phi) = |a|e^{-i\phi} = |a| \cos(\phi) + i|a| \sin(\phi) = X_1 + iX_2, \quad \phi = \omega t - kz$$

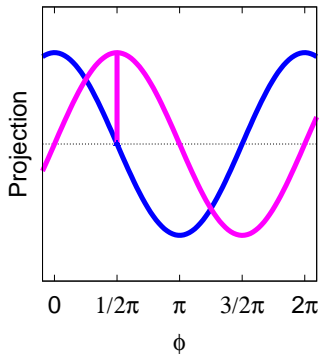
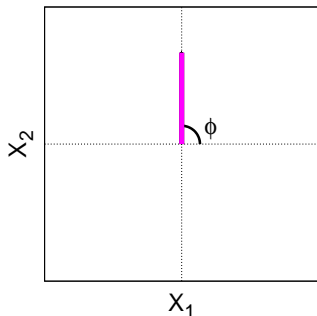

# Classical field

$$E(\phi) = |a|e^{-i\phi} = |a| \cos(\phi) + i|a| \sin(\phi) = X_1 + iX_2, \quad \phi = \omega t - kz$$

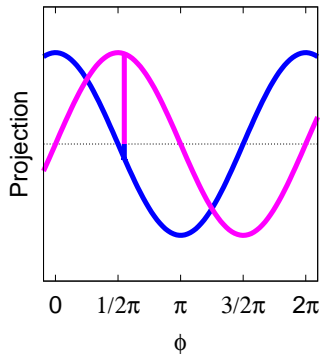
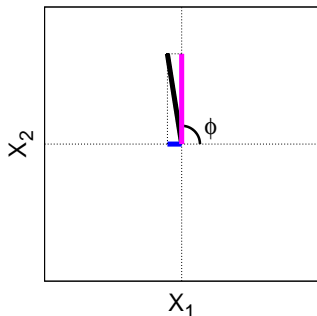



# Classical field

$$E(\phi) = |a|e^{-i\phi} = |a| \cos(\phi) + i|a| \sin(\phi) = X_1 + iX_2, \quad \phi = \omega t - kz$$

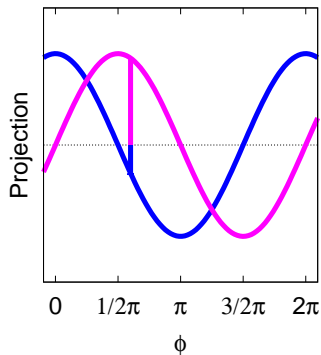
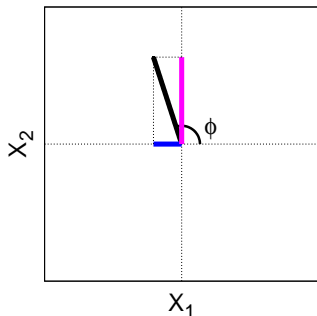

# Classical field

$$E(\phi) = |a|e^{-i\phi} = |a| \cos(\phi) + i|a| \sin(\phi) = X_1 + iX_2, \quad \phi = \omega t - kz$$

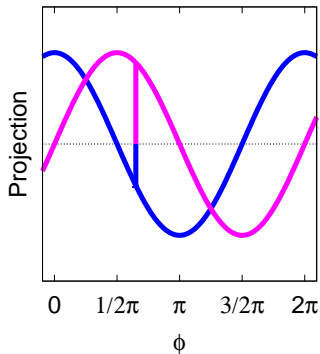
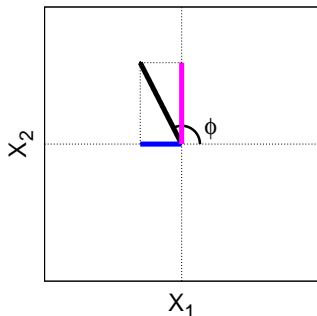

# Classical field

$$E(\phi) = |a|e^{-i\phi} = |a|\cos(\phi) + i|a|\sin(\phi) = X_1 + iX_2, \quad \phi = \omega t - kz$$

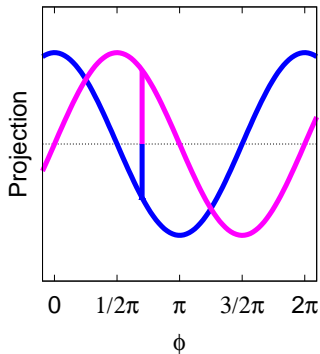
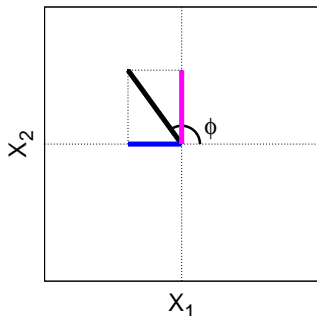

# Classical field

$$E(\phi) = |a|e^{-i\phi} = |a| \cos(\phi) + i|a| \sin(\phi) = X_1 + iX_2, \quad \phi = \omega t - kz$$

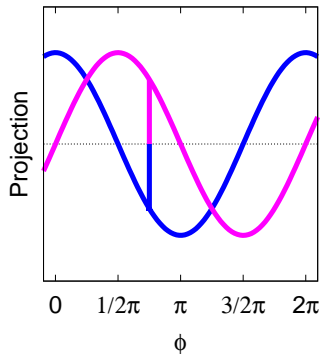
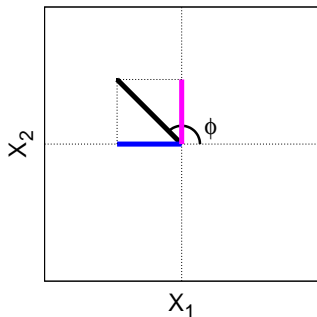

# Classical field

$$E(\phi) = |a|e^{-i\phi} = |a| \cos(\phi) + i|a| \sin(\phi) = X_1 + iX_2, \quad \phi = \omega t - kz$$

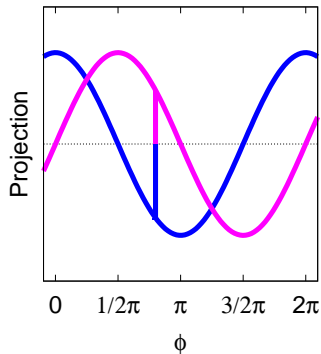
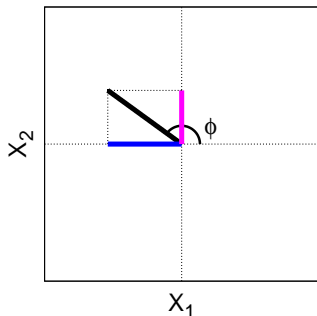

# Classical field

$$E(\phi) = |a|e^{-i\phi} = |a|\cos(\phi) + i|a|\sin(\phi) = X_1 + iX_2, \quad \phi = \omega t - kz$$

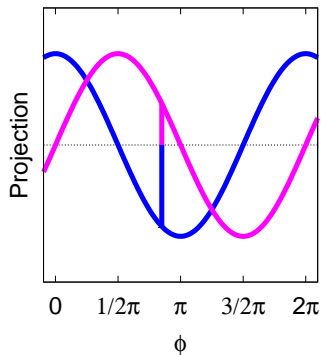
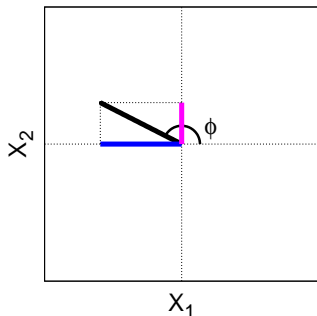

# Classical field

$$E(\phi) = |a|e^{-i\phi} = |a| \cos(\phi) + i|a| \sin(\phi) = X_1 + iX_2, \quad \phi = \omega t - kz$$

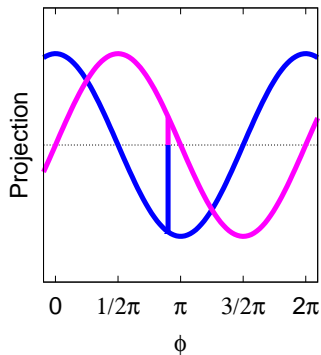
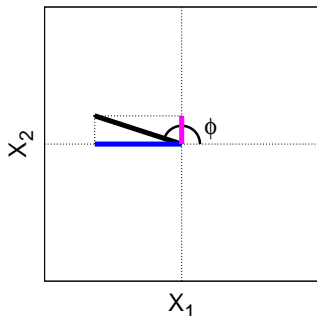

# Classical field

$$E(\phi) = |a|e^{-i\phi} = |a| \cos(\phi) + i|a| \sin(\phi) = X_1 + iX_2, \quad \phi = \omega t - kz$$

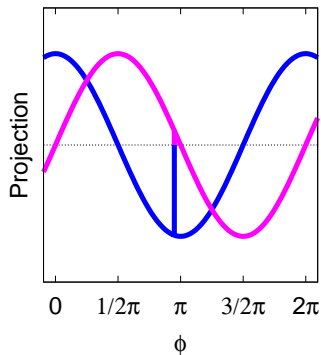
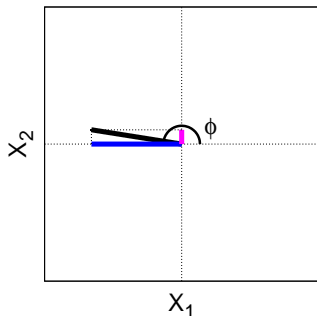



# Classical field

$$E(\phi) = |a|e^{-i\phi} = |a|\cos(\phi) + i|a|\sin(\phi) = X_1 + iX_2, \quad \phi = \omega t - kz$$

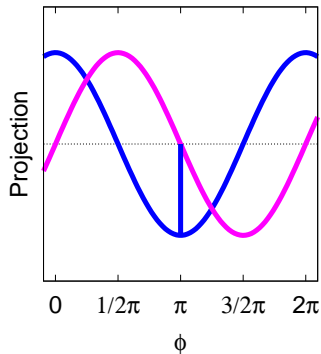
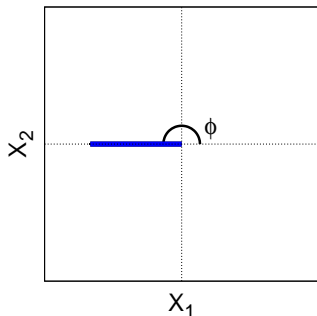

# Classical field

$$E(\phi) = |a|e^{-i\phi} = |a|\cos(\phi) + i|a|\sin(\phi) = X_1 + iX_2, \quad \phi = \omega t - kz$$

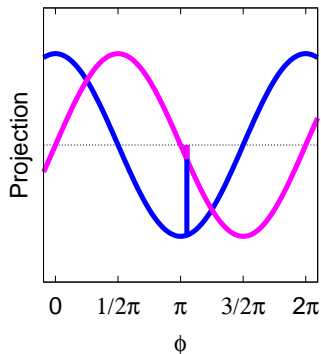
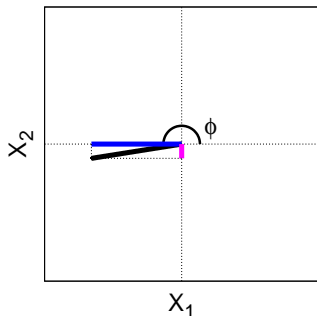

# Classical field

$$E(\phi) = |a|e^{-i\phi} = |a| \cos(\phi) + i|a| \sin(\phi) = X_1 + iX_2, \quad \phi = \omega t - kz$$

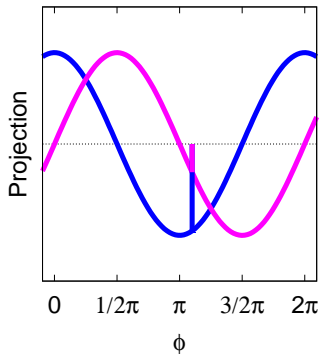
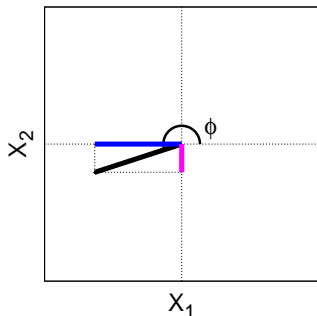

# Classical field

$$E(\phi) = |a|e^{-i\phi} = |a| \cos(\phi) + i|a| \sin(\phi) = X_1 + iX_2, \quad \phi = \omega t - kz$$

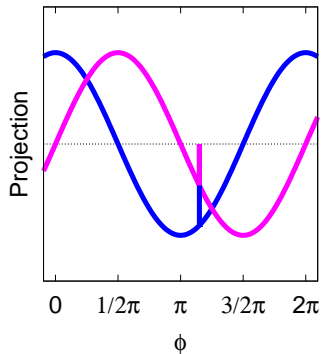
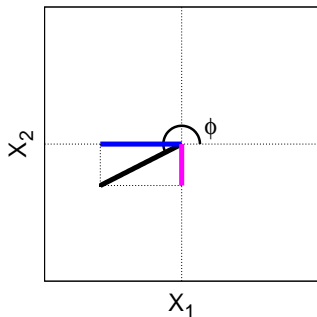

# Classical field

$$E(\phi) = |a|e^{-i\phi} = |a|\cos(\phi) + i|a|\sin(\phi) = X_1 + iX_2, \quad \phi = \omega t - kz$$

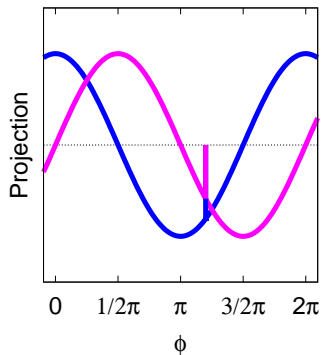
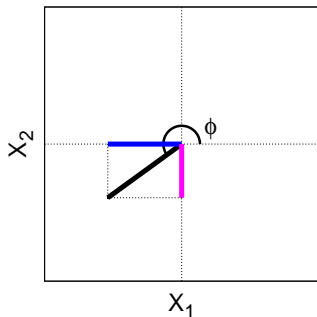

# Classical field

$$E(\phi) = |a|e^{-i\phi} = |a| \cos(\phi) + i|a| \sin(\phi) = X_1 + iX_2, \quad \phi = \omega t - kz$$

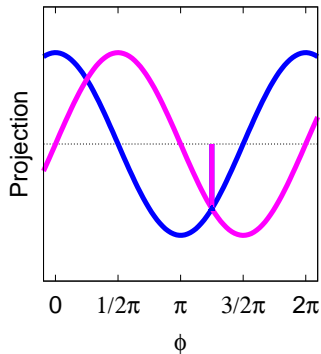
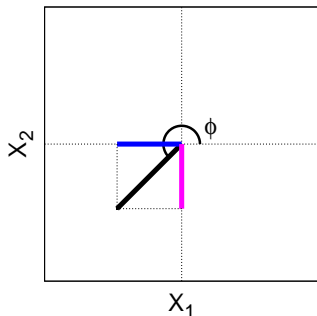

# Classical field

$$E(\phi) = |a|e^{-i\phi} = |a| \cos(\phi) + i|a| \sin(\phi) = X_1 + iX_2, \quad \phi = \omega t - kz$$

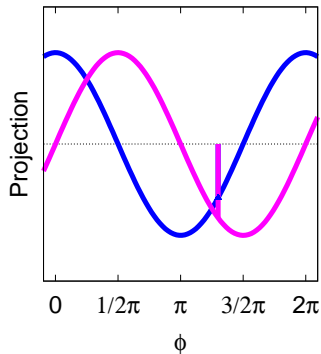
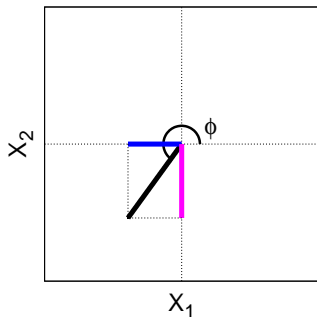

# Classical field

$$E(\phi) = |a|e^{-i\phi} = |a| \cos(\phi) + i|a| \sin(\phi) = X_1 + iX_2, \quad \phi = \omega t - kz$$

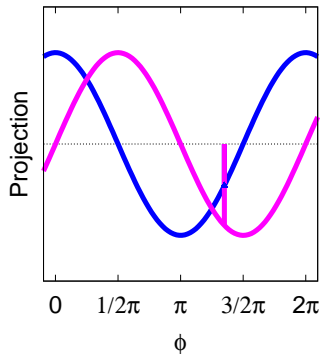
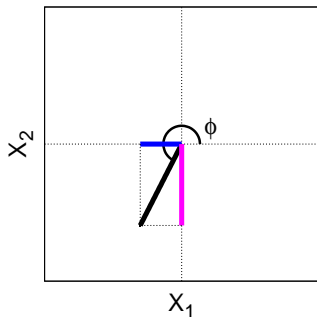



# Classical field

$$E(\phi) = |a|e^{-i\phi} = |a| \cos(\phi) + i|a| \sin(\phi) = X_1 + iX_2, \quad \phi = \omega t - kz$$

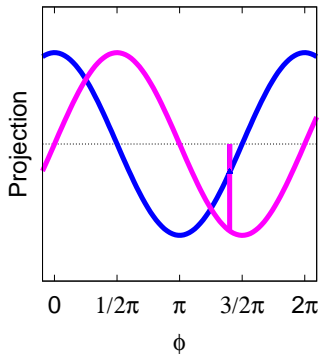
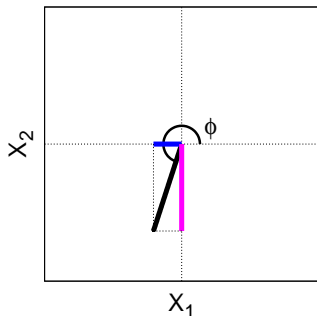

# Classical field

$$E(\phi) = |a|e^{-i\phi} = |a|\cos(\phi) + i|a|\sin(\phi) = X_1 + iX_2, \quad \phi = \omega t - kz$$

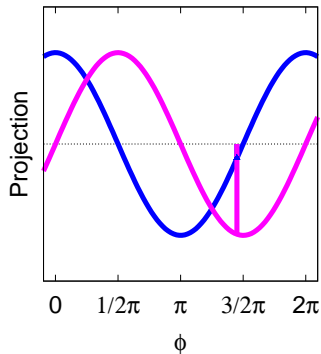
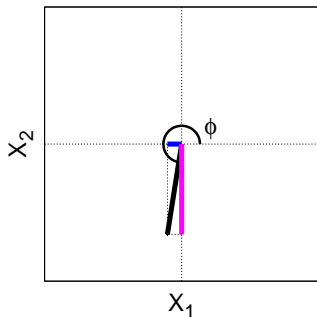

# Classical field

$$E(\phi) = |a|e^{-i\phi} = |a| \cos(\phi) + i|a| \sin(\phi) = X_1 + iX_2, \quad \phi = \omega t - kz$$

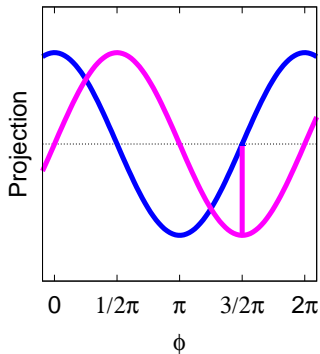
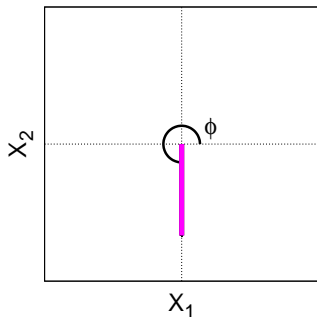

# Classical field

$$E(\phi) = |a|e^{-i\phi} = |a| \cos(\phi) + i|a| \sin(\phi) = X_1 + iX_2, \quad \phi = \omega t - kz$$

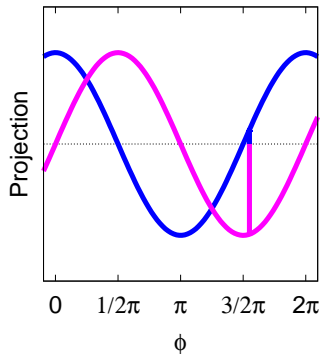
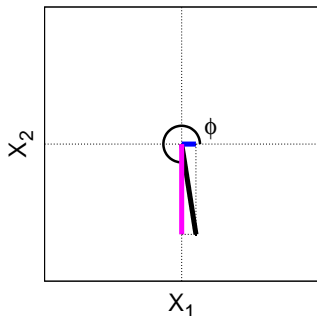

# Classical field

$$E(\phi) = |a|e^{-i\phi} = |a| \cos(\phi) + i|a| \sin(\phi) = X_1 + iX_2, \quad \phi = \omega t - kz$$

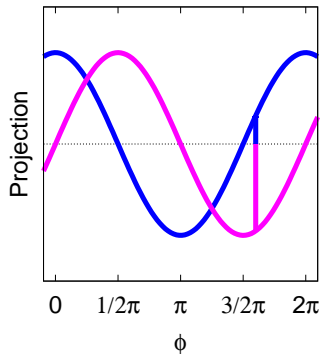
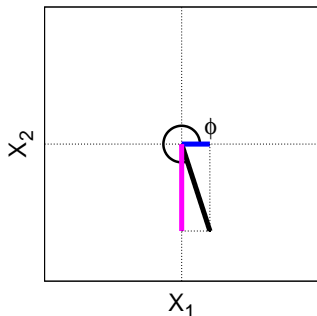

# Classical field

$$E(\phi) = |a|e^{-i\phi} = |a|\cos(\phi) + i|a|\sin(\phi) = X_1 + iX_2, \quad \phi = \omega t - kz$$

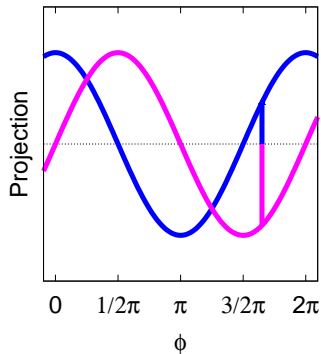
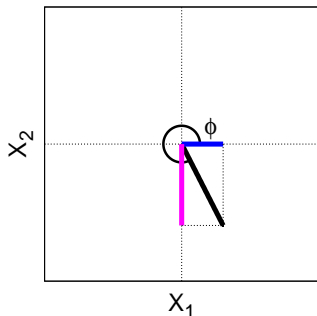

# Classical field

$$E(\phi) = |a|e^{-i\phi} = |a| \cos(\phi) + i|a| \sin(\phi) = X_1 + iX_2, \quad \phi = \omega t - kz$$

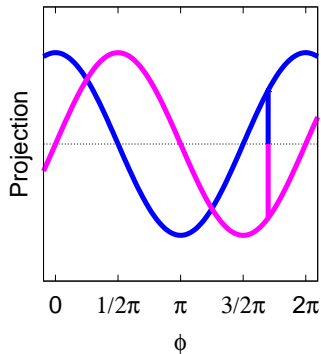
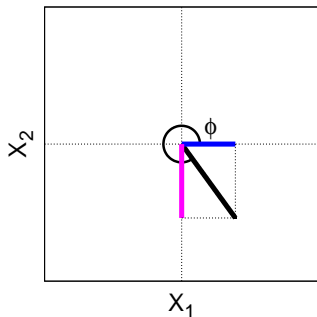

# Classical field

$$E(\phi) = |a|e^{-i\phi} = |a| \cos(\phi) + i|a| \sin(\phi) = X_1 + iX_2, \quad \phi = \omega t - kz$$

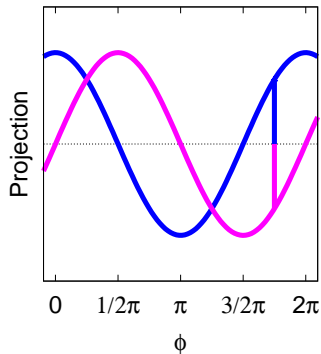
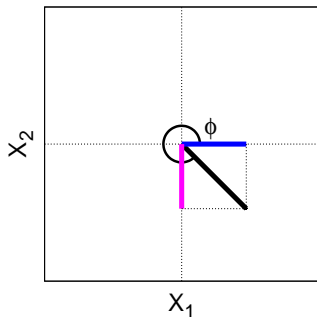



# Classical field

$$E(\phi) = |a|e^{-i\phi} = |a|\cos(\phi) + i|a|\sin(\phi) = X_1 + iX_2, \quad \phi = \omega t - kz$$

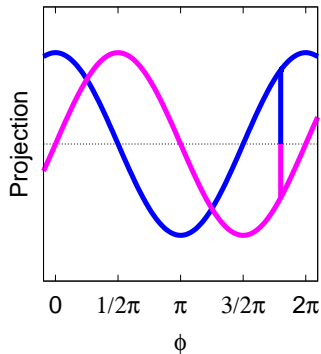
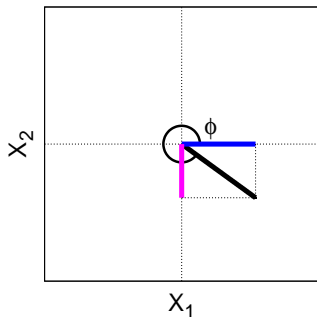

# Classical field

$$E(\phi) = |a|e^{-i\phi} = |a|\cos(\phi) + i|a|\sin(\phi) = X_1 + iX_2, \quad \phi = \omega t - kz$$

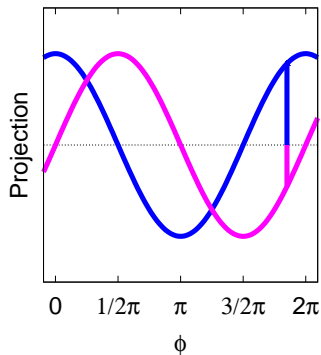
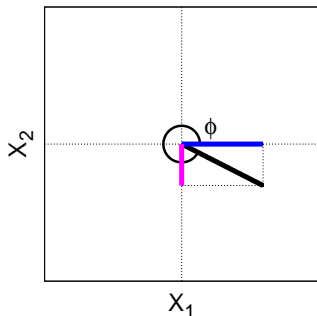

# Classical field

$$E(\phi) = |a|e^{-i\phi} = |a| \cos(\phi) + i|a| \sin(\phi) = X_1 + iX_2, \quad \phi = \omega t - kz$$

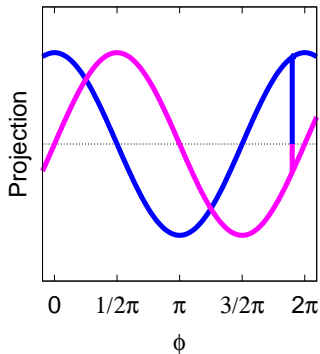
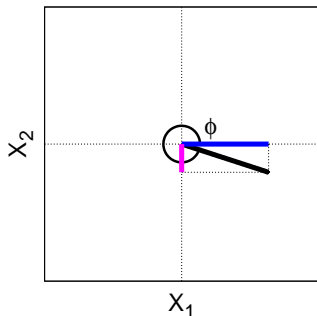

# Classical quadratures vs time in a rotating frame

$$E(\phi) = |a|e^{-i\phi} = |a|\cos(\phi) + i|a|\sin(\phi) = X_1 + iX_2, \quad \phi = \omega t - kz$$

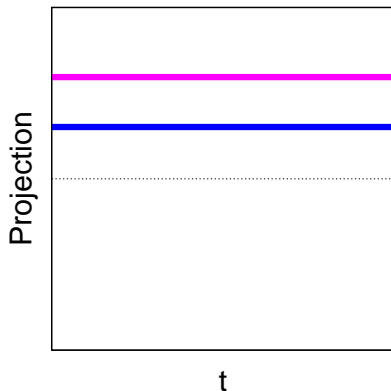
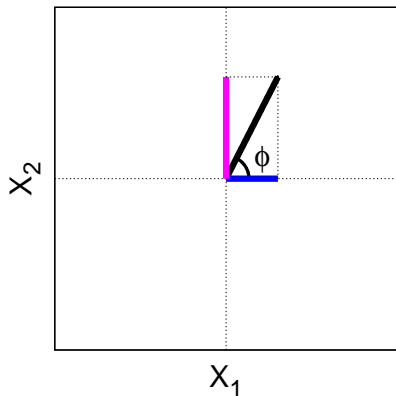

# Reality check quadratures vs time

$$E(\phi) = |a|e^{-i\phi} = |a|\cos(\phi) + i|a|\sin(\phi) = X_1 + iX_2, \quad \phi = \omega t - kz$$

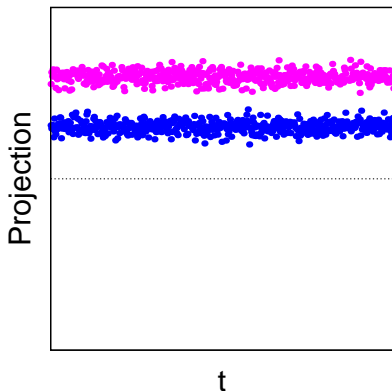
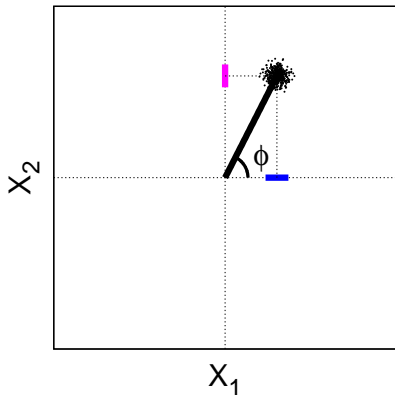

# Detector quantum noise

Simple photodetector

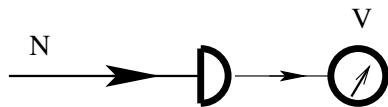

$$V \sim N$$

$$\Delta V \sim \sqrt{N}$$

# Detector quantum noise

## Simple photodetector

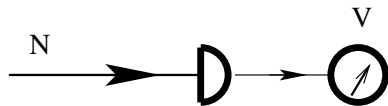

$$V \sim N$$

$$\Delta V \sim \sqrt{N}$$

## Balanced photodetector

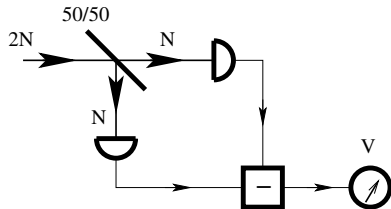

$$V = 0$$

$$\Delta V \sim \sqrt{N}$$

# Transition from classical to quantum field

## Classical analog

- Field amplitude  $a$
- Field real part  
 $X_1 = (a^* + a)/2$
- Field imaginary part  
 $X_2 = i(\hat{a}^* - a)/2$

$$E(\phi) = |a|e^{-i\phi} = X_1 + iX_2$$

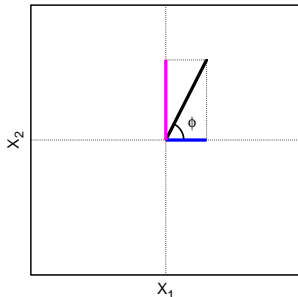

## Quantum approach

- Field operator  $\hat{a}$
- Amplitude quadrature  
 $\hat{X}_1 = (\hat{a}^\dagger + \hat{a})/2$
- Phase quadrature  
 $\hat{X}_2 = i(\hat{a}^\dagger - \hat{a})/2$

$$\hat{E}(\phi) = \hat{X}_1 + i\hat{X}_2$$

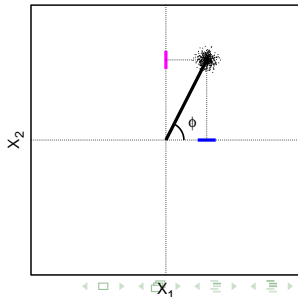



# Heisenberg uncertainty principle and its optics equivalent



## Heisenberg uncertainty principle

$$\Delta p \Delta x \geq \hbar/2$$

The more precisely the POSITION is determined, the less precisely the MOMENTUM is known, and vice versa

# Heisenberg uncertainty principle and its optics equivalent



## Heisenberg uncertainty principle

$$\Delta p \Delta x \geq \hbar/2$$

The more precisely the POSITION is determined, the less precisely the MOMENTUM is known, and vice versa

## Optics equivalent

$$\Delta \phi \Delta N \geq 1$$

The more precisely the PHASE is determined, the less precisely the AMPLITUDE is known, and vice versa

# Heisenberg uncertainty principle and its optics equivalent



## Heisenberg uncertainty principle

$$\Delta p \Delta x \geq \hbar/2$$

The more precisely the POSITION is determined, the less precisely the MOMENTUM is known, and vice versa

## Optics equivalent

$$\Delta \phi \Delta N \geq 1$$

The more precisely the PHASE is determined, the less precisely the AMPLITUDE is known, and vice versa

## Optics equivalent strict definition

$$\langle \Delta X_1 \rangle \langle \Delta X_2 \rangle \geq 1/4$$

# Quantum optics summary

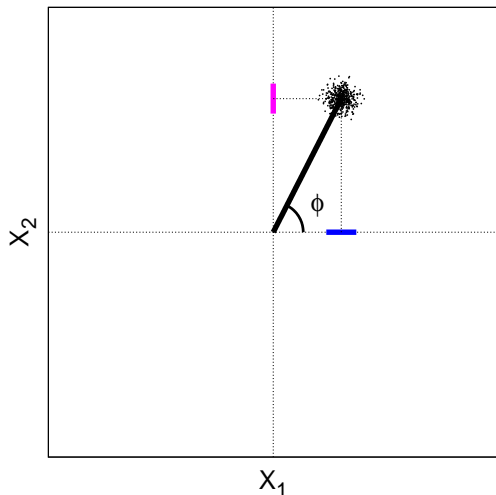

Light consist of photons

- $\hat{N} = a^\dagger a$

Commutator relationship

- $[a, a^\dagger] = 1$

- $[X_1, X_2] = i/2$

Detectors measure

- number of photons  $N$
- Quadratures  $\hat{X}_1$  and  $\hat{X}_2$

Uncertainty relationship

- $\Delta X_1 \Delta X_2 \geq 1/4$

# Coherent state is minimum uncertainty state

$$\Delta X_1 \Delta X_2 = 1/4$$

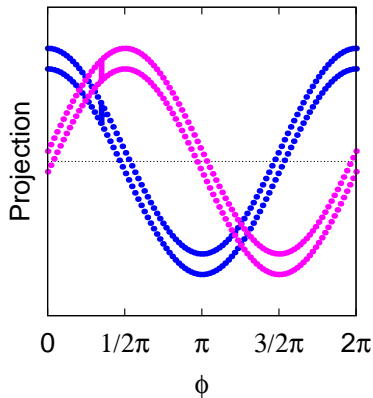
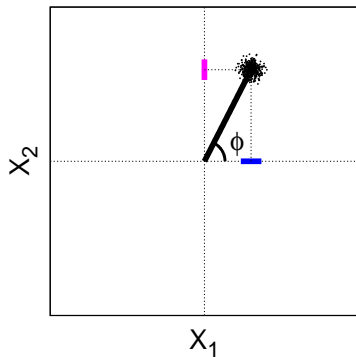

# Coherent state is minimum uncertainty state

$$\Delta X_1 \Delta X_2 = 1/4$$

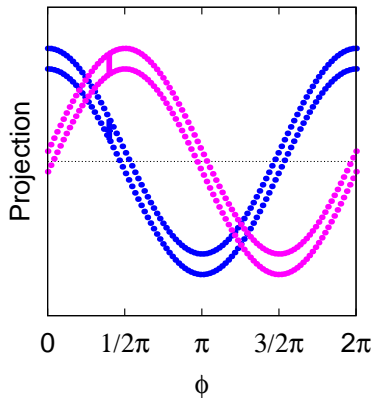
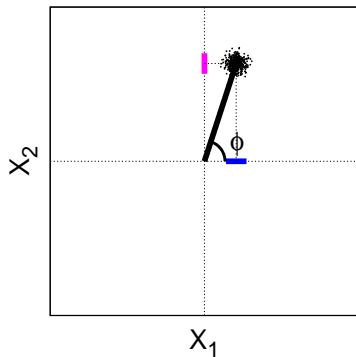

# Coherent state is minimum uncertainty state

$$\Delta X_1 \Delta X_2 = 1/4$$

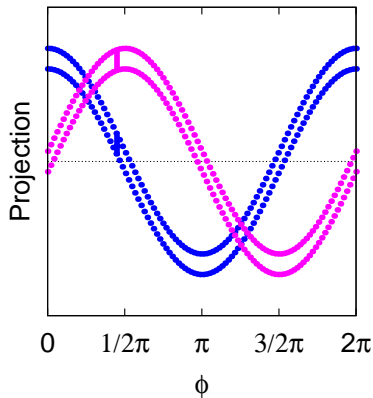
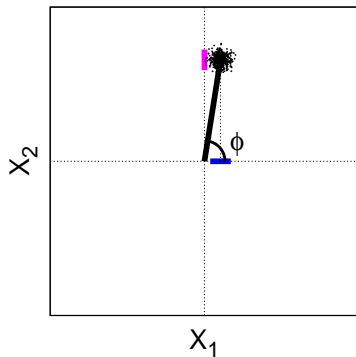

# Coherent state is minimum uncertainty state

$$\Delta X_1 \Delta X_2 = 1/4$$

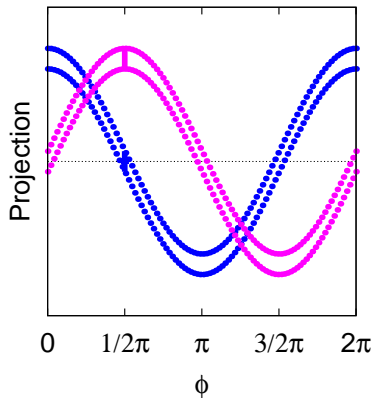
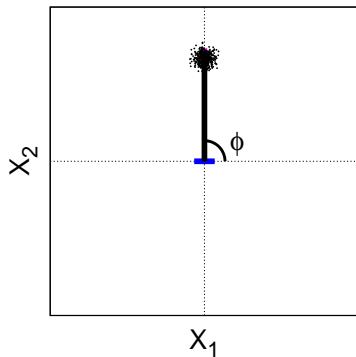



# Coherent state is minimum uncertainty state

$$\Delta X_1 \Delta X_2 = 1/4$$

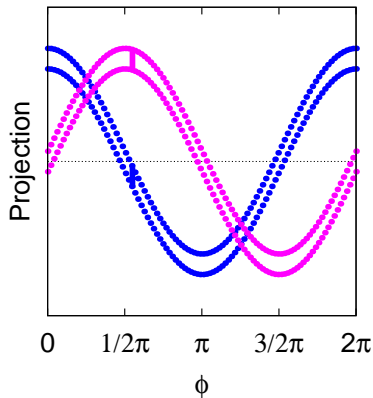
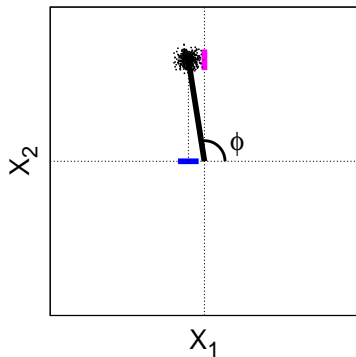

# Coherent state is minimum uncertainty state

$$\Delta X_1 \Delta X_2 = 1/4$$

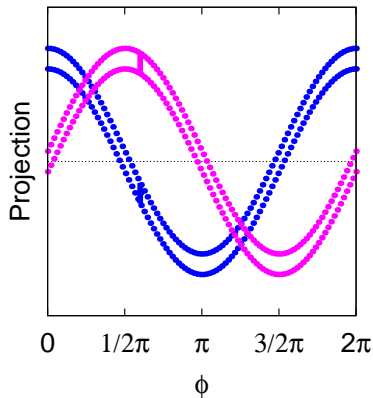
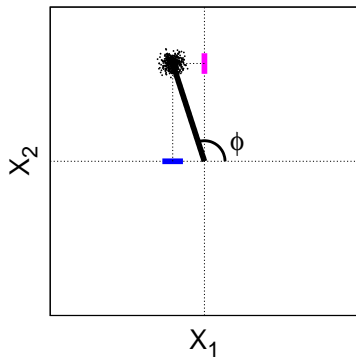

# Coherent state is minimum uncertainty state

$$\Delta X_1 \Delta X_2 = 1/4$$

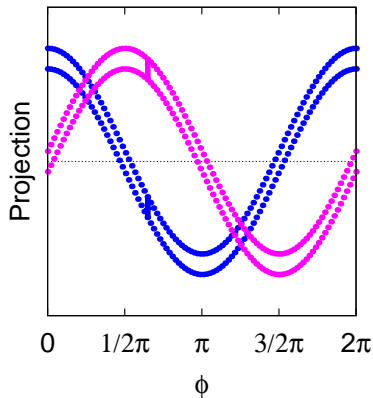
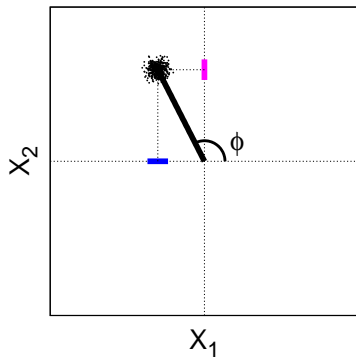

# Coherent state is minimum uncertainty state

$$\Delta X_1 \Delta X_2 = 1/4$$

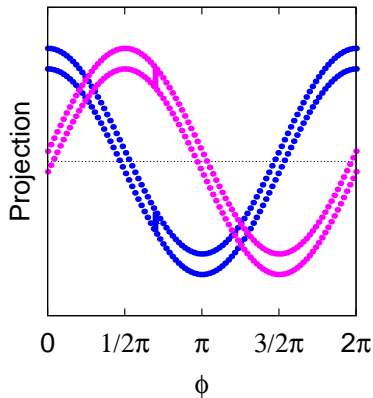
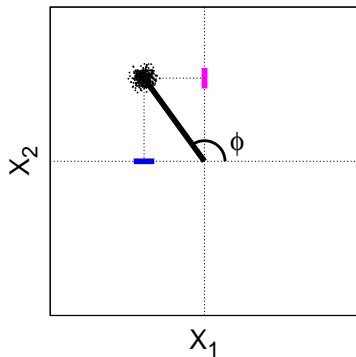

# Coherent state is minimum uncertainty state

$$\Delta X_1 \Delta X_2 = 1/4$$

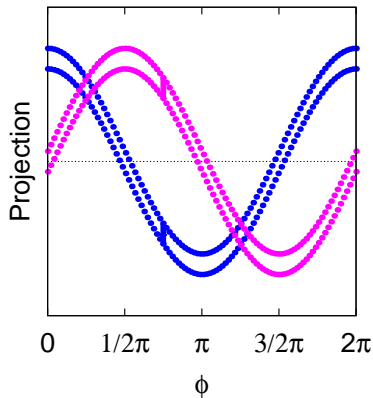
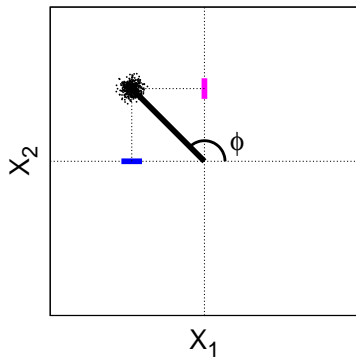

# Coherent state is minimum uncertainty state

$$\Delta X_1 \Delta X_2 = 1/4$$

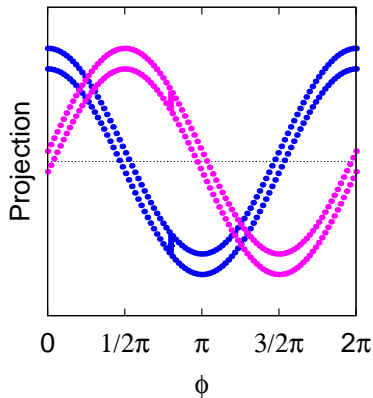
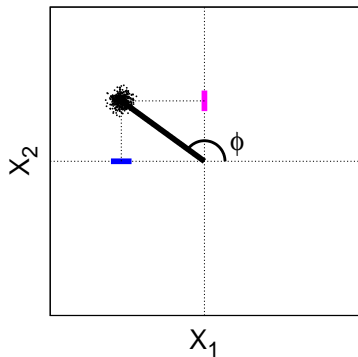

# Coherent state is minimum uncertainty state

$$\Delta X_1 \Delta X_2 = 1/4$$

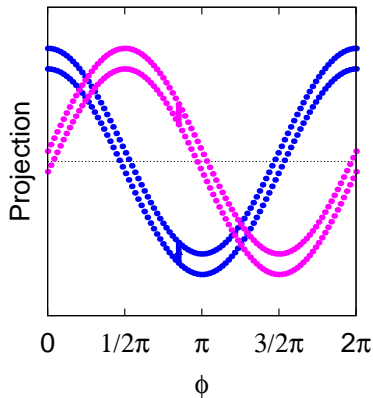
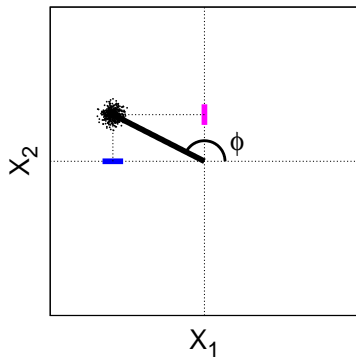

# Coherent state is minimum uncertainty state

$$\Delta X_1 \Delta X_2 = 1/4$$

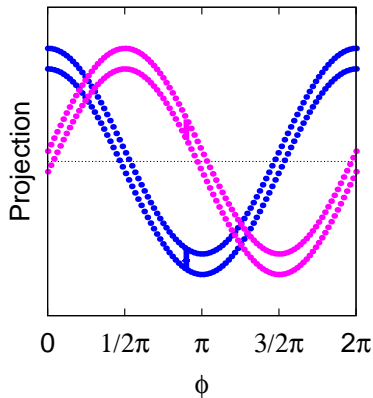
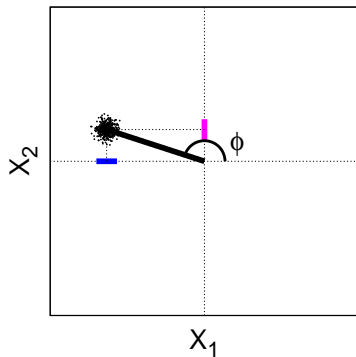



# Coherent state is minimum uncertainty state

$$\Delta X_1 \Delta X_2 = 1/4$$

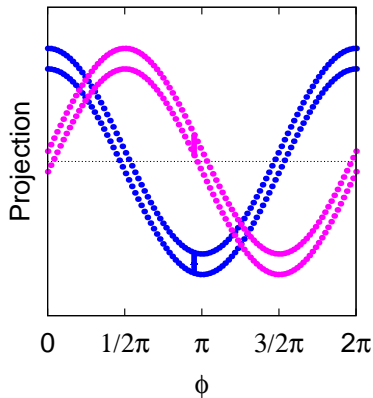
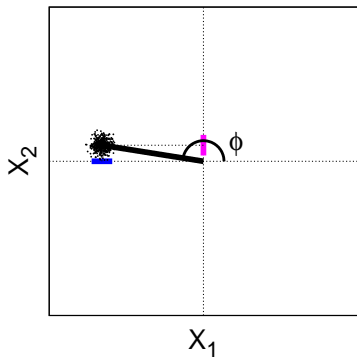

# Coherent state is minimum uncertainty state

$$\Delta X_1 \Delta X_2 = 1/4$$

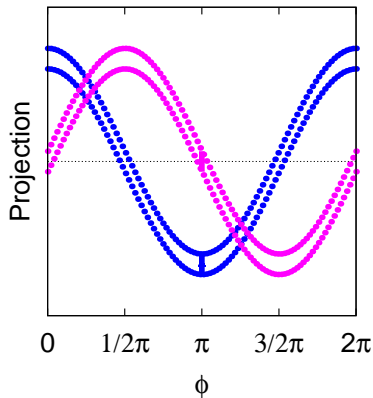
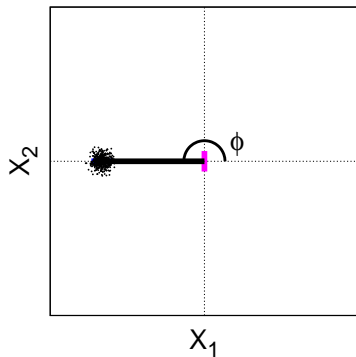

# Coherent state is minimum uncertainty state

$$\Delta X_1 \Delta X_2 = 1/4$$

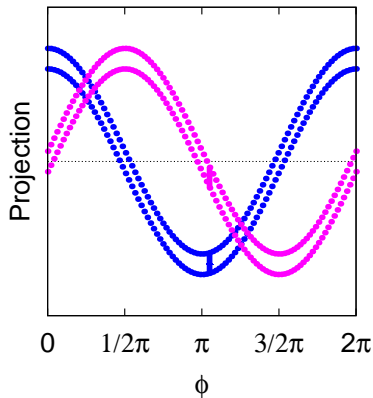
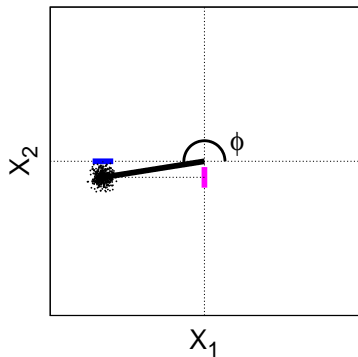

# Coherent state is minimum uncertainty state

$$\Delta X_1 \Delta X_2 = 1/4$$

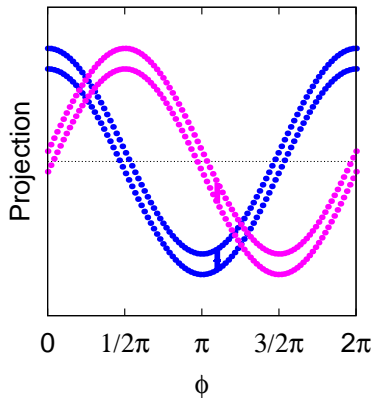
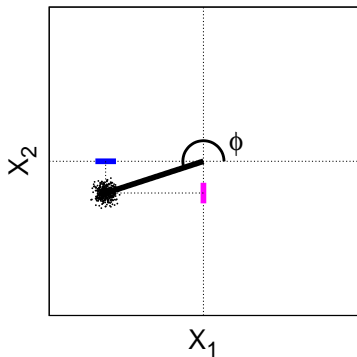

# Coherent state is minimum uncertainty state

$$\Delta X_1 \Delta X_2 = 1/4$$

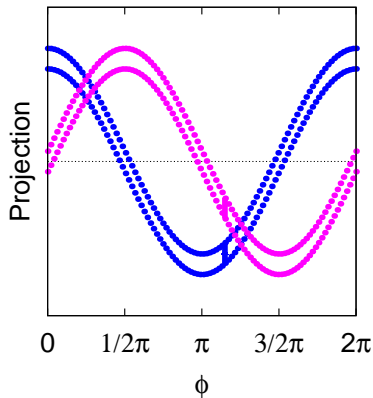
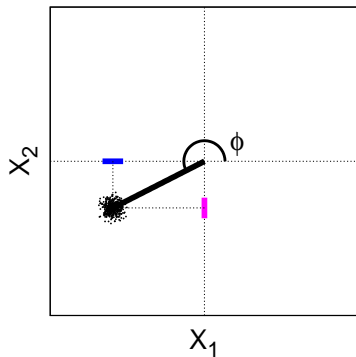

# Coherent state is minimum uncertainty state

$$\Delta X_1 \Delta X_2 = 1/4$$

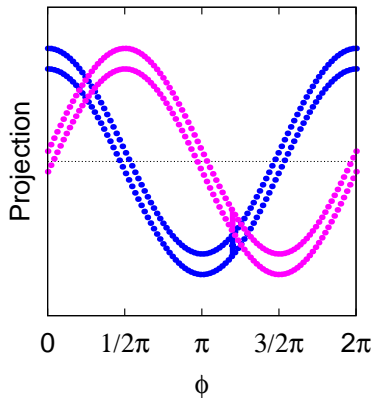
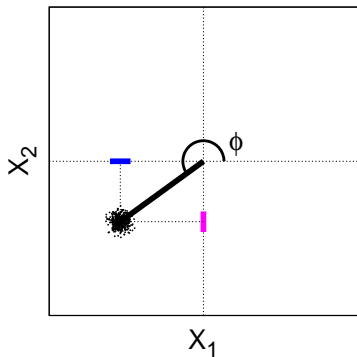

# Coherent state is minimum uncertainty state

$$\Delta X_1 \Delta X_2 = 1/4$$

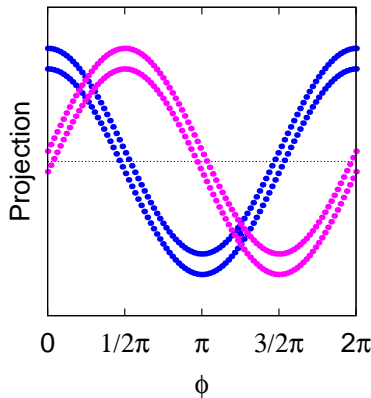
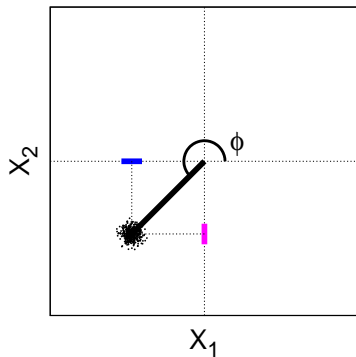

# Coherent state is minimum uncertainty state

$$\Delta X_1 \Delta X_2 = 1/4$$

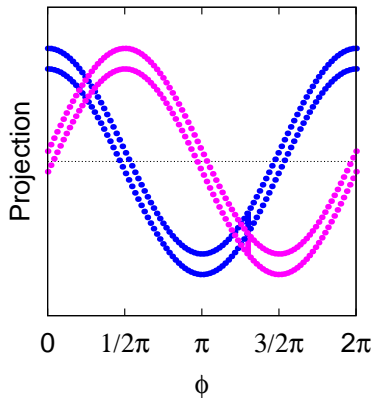
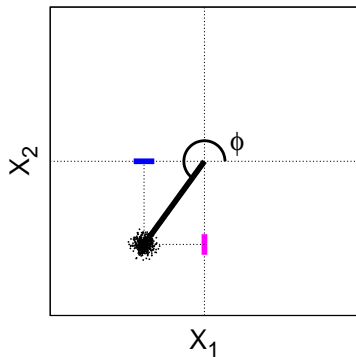



# Coherent state is minimum uncertainty state

$$\Delta X_1 \Delta X_2 = 1/4$$

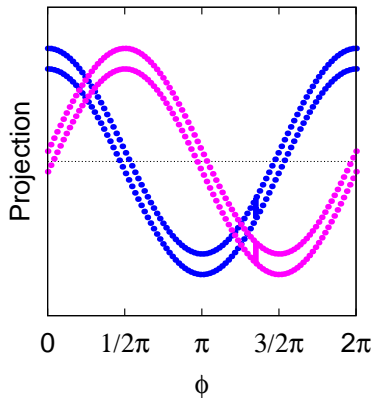
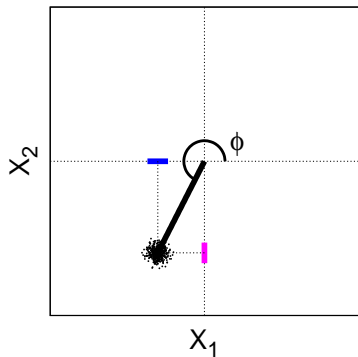

# Coherent state is minimum uncertainty state

$$\Delta X_1 \Delta X_2 = 1/4$$

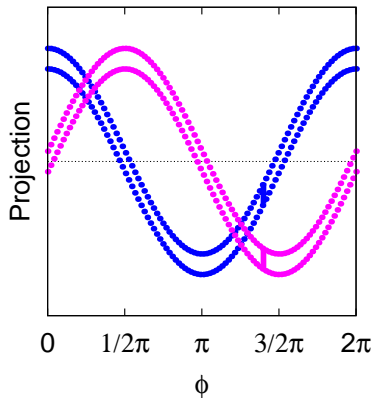
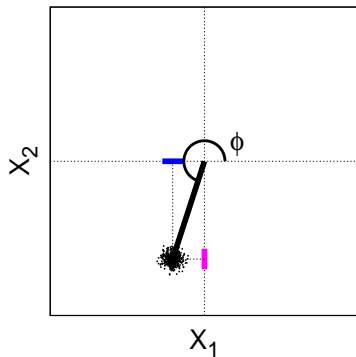

# Coherent state is minimum uncertainty state

$$\Delta X_1 \Delta X_2 = 1/4$$

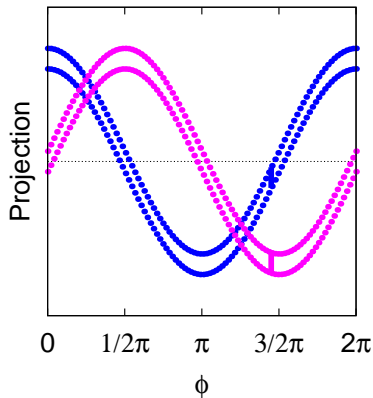
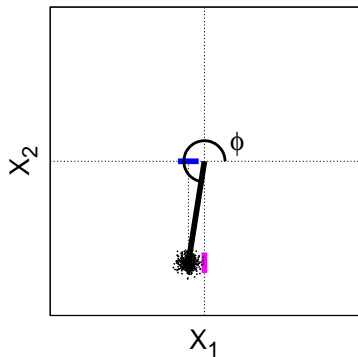

# Coherent state is minimum uncertainty state

$$\Delta X_1 \Delta X_2 = 1/4$$

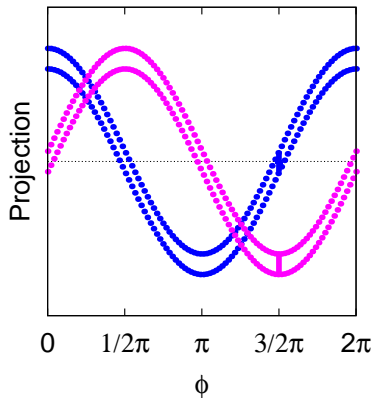
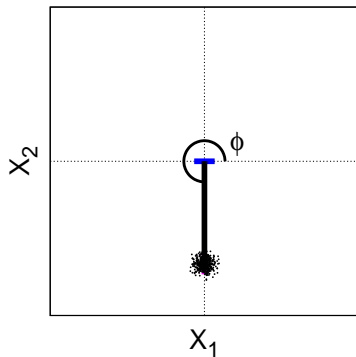

# Coherent state is minimum uncertainty state

$$\Delta X_1 \Delta X_2 = 1/4$$

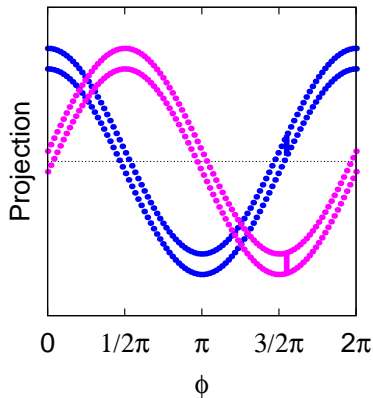
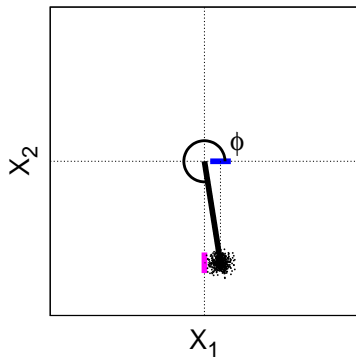

# Coherent state is minimum uncertainty state

$$\Delta X_1 \Delta X_2 = 1/4$$

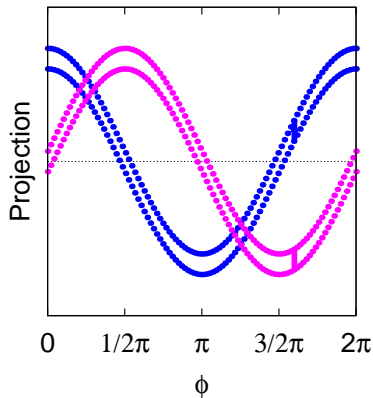
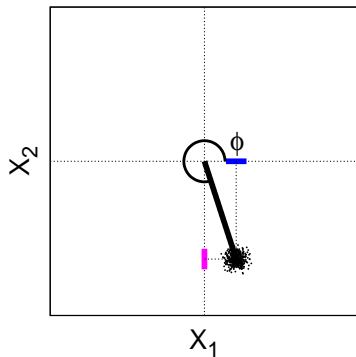

# Coherent state is minimum uncertainty state

$$\Delta X_1 \Delta X_2 = 1/4$$

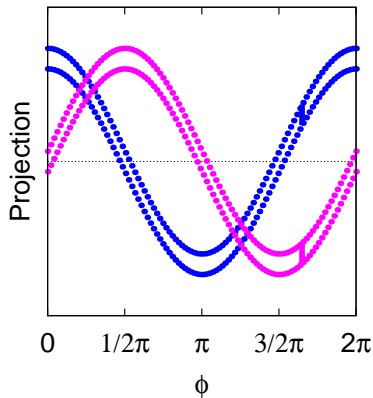
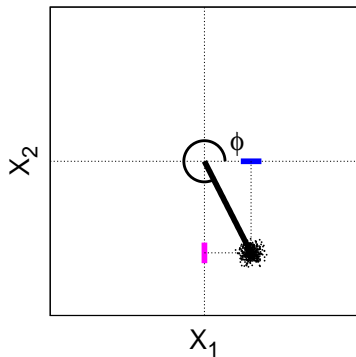

# Coherent state is minimum uncertainty state

$$\Delta X_1 \Delta X_2 = 1/4$$

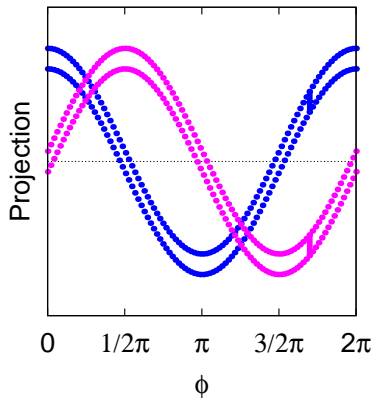
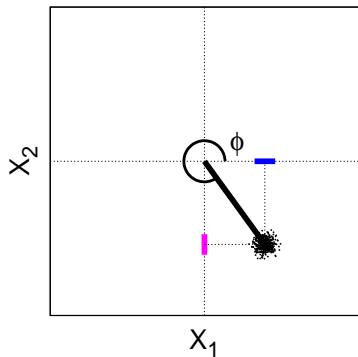



# Coherent state is minimum uncertainty state

$$\Delta X_1 \Delta X_2 = 1/4$$

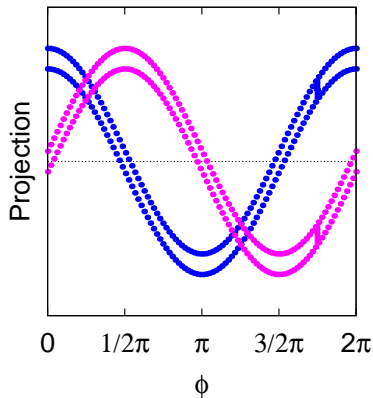
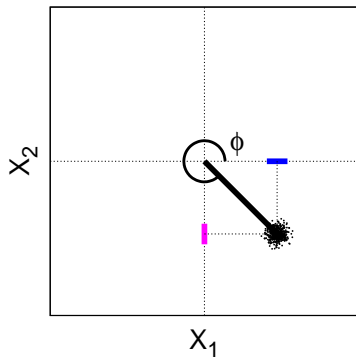

# Coherent state is minimum uncertainty state

$$\Delta X_1 \Delta X_2 = 1/4$$

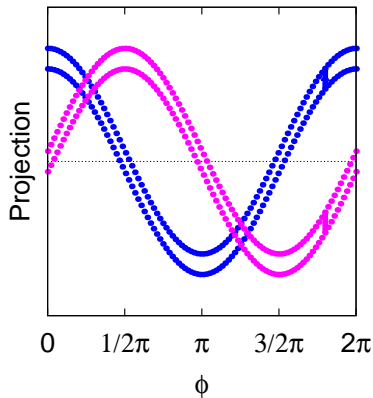
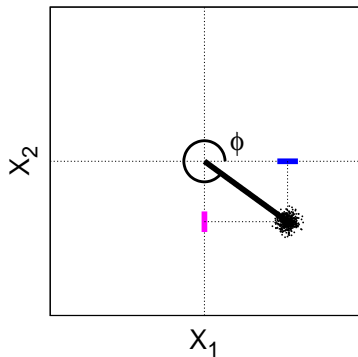

# Coherent state is minimum uncertainty state

$$\Delta X_1 \Delta X_2 = 1/4$$

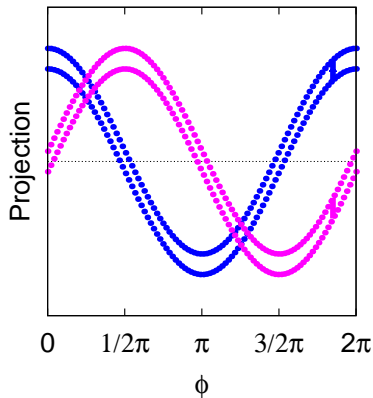
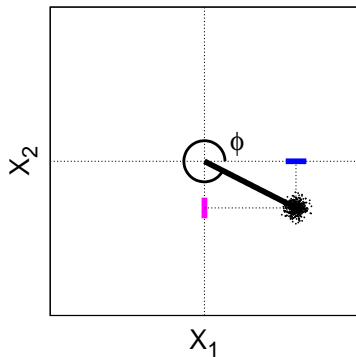

# Coherent state is minimum uncertainty state

$$\Delta X_1 \Delta X_2 = 1/4$$

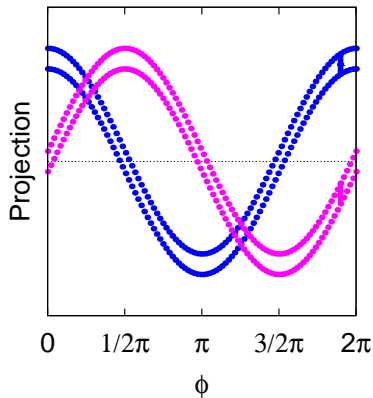
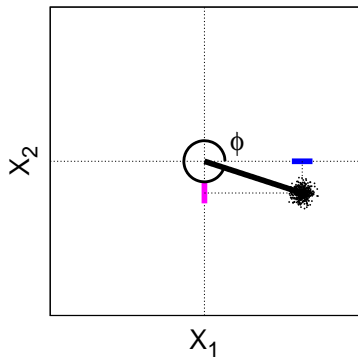

# Amplitude squeezed states

$$\Delta X_1 \Delta X_2 = 1/4$$

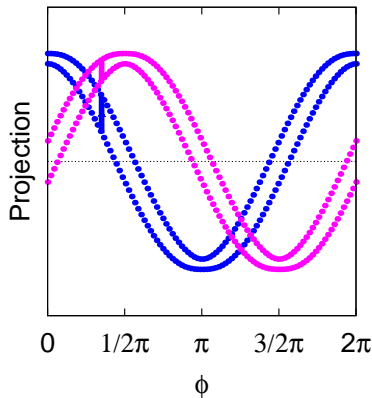
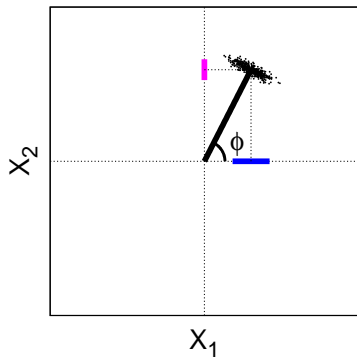

# Amplitude squeezed states

$$\Delta X_1 \Delta X_2 = 1/4$$

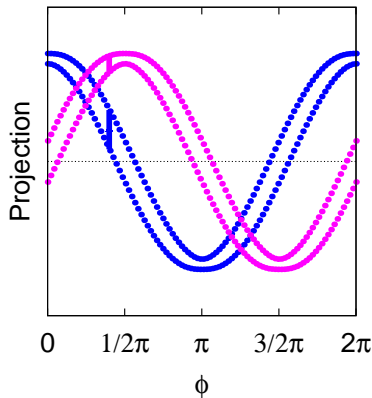
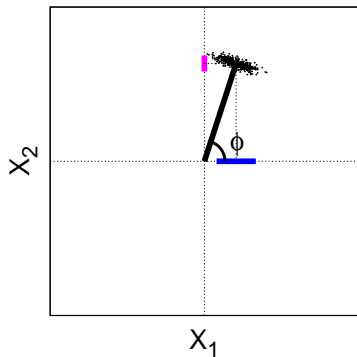

# Amplitude squeezed states

$$\Delta X_1 \Delta X_2 = 1/4$$

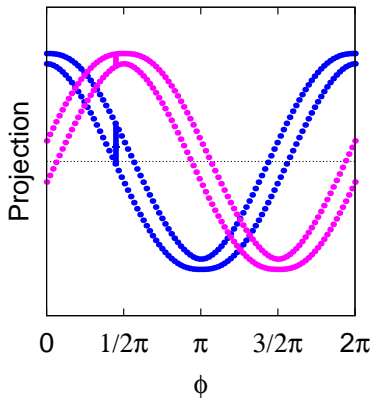
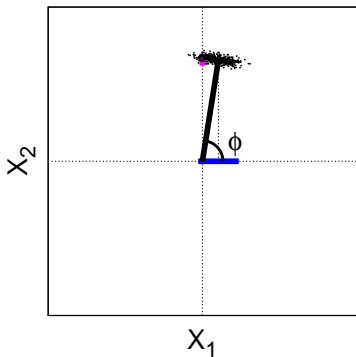

# Amplitude squeezed states

$$\Delta X_1 \Delta X_2 = 1/4$$

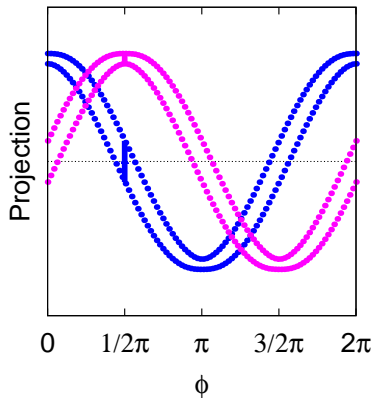
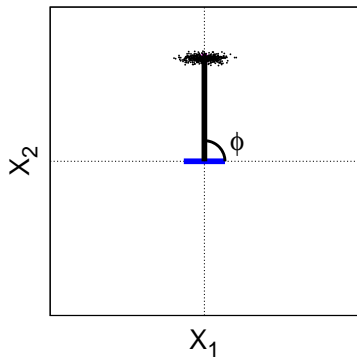



# Amplitude squeezed states

$$\Delta X_1 \Delta X_2 = 1/4$$

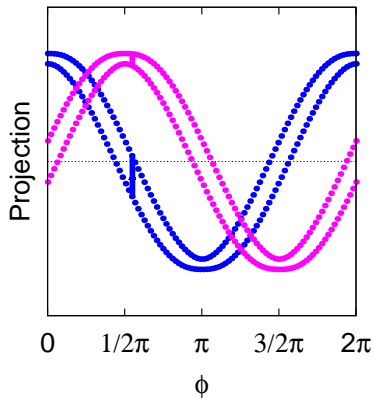
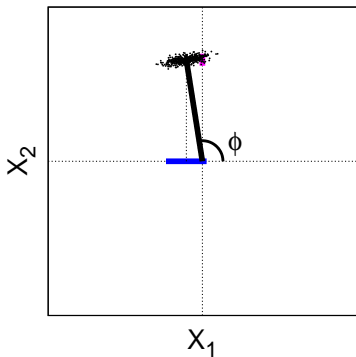

# Amplitude squeezed states

$$\Delta X_1 \Delta X_2 = 1/4$$

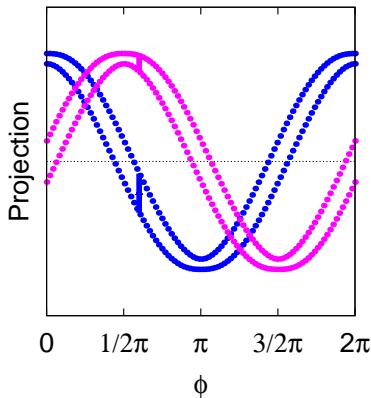
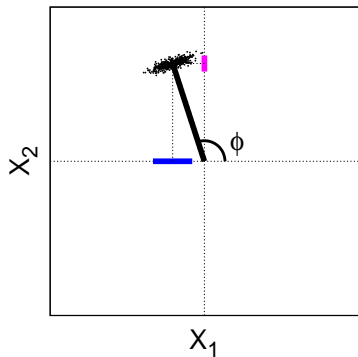

# Amplitude squeezed states

$$\Delta X_1 \Delta X_2 = 1/4$$

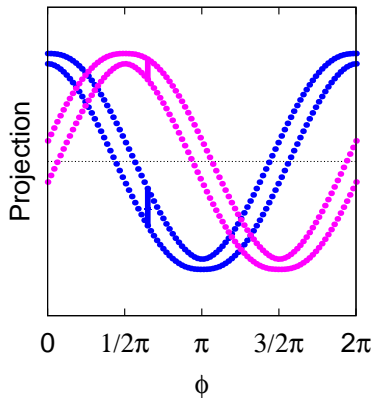
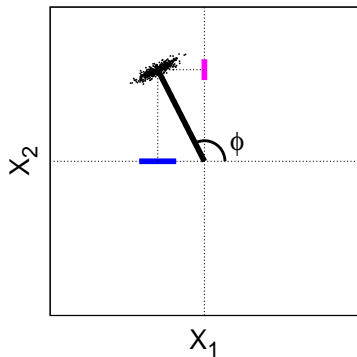

# Amplitude squeezed states

$$\Delta X_1 \Delta X_2 = 1/4$$

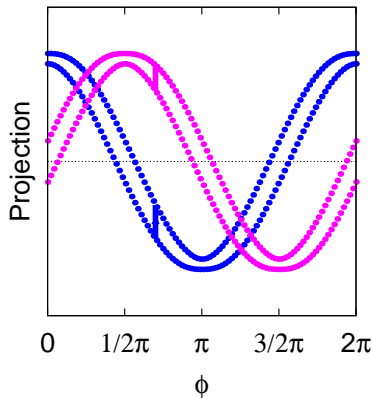
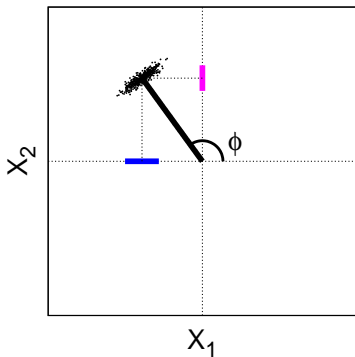

# Amplitude squeezed states

$$\Delta X_1 \Delta X_2 = 1/4$$

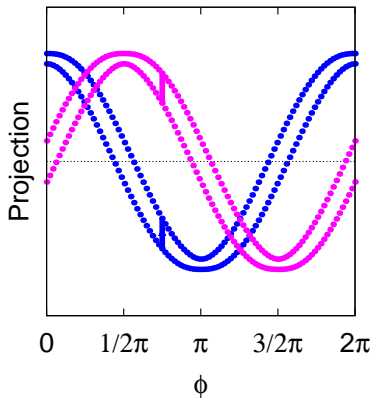
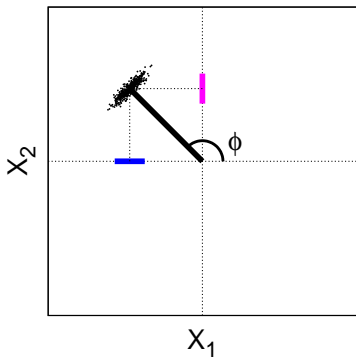

# Amplitude squeezed states

$$\Delta X_1 \Delta X_2 = 1/4$$

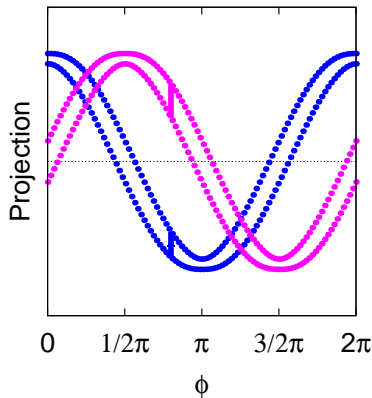
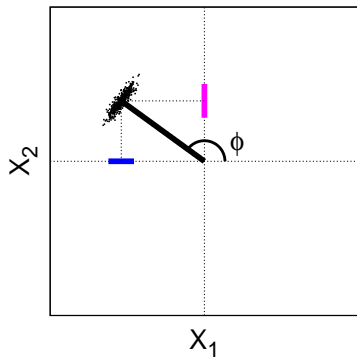

# Amplitude squeezed states

$$\Delta X_1 \Delta X_2 = 1/4$$

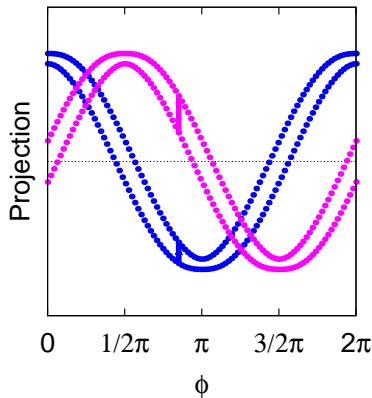
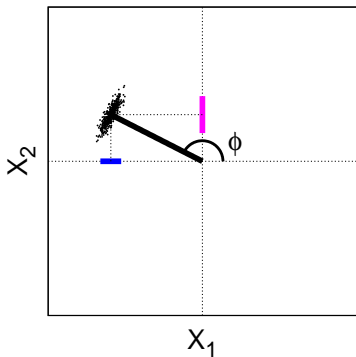

# Amplitude squeezed states

$$\Delta X_1 \Delta X_2 = 1/4$$

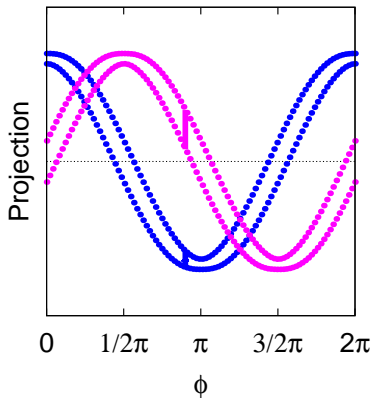
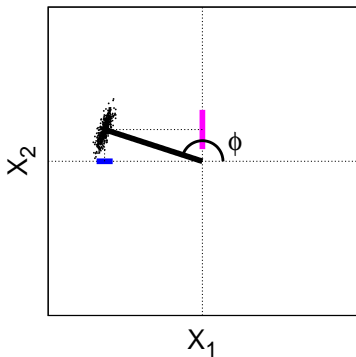



# Amplitude squeezed states

$$\Delta X_1 \Delta X_2 = 1/4$$

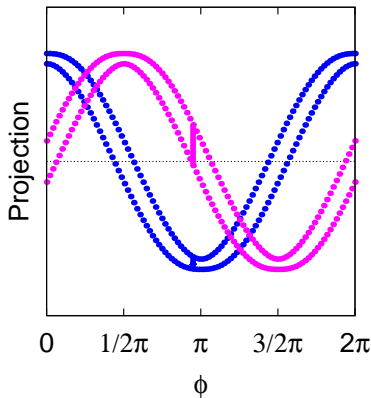
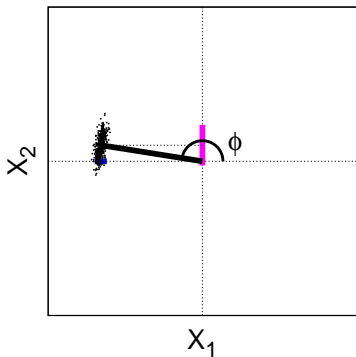

# Amplitude squeezed states

$$\Delta X_1 \Delta X_2 = 1/4$$

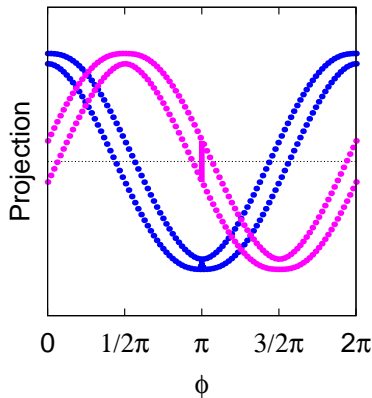
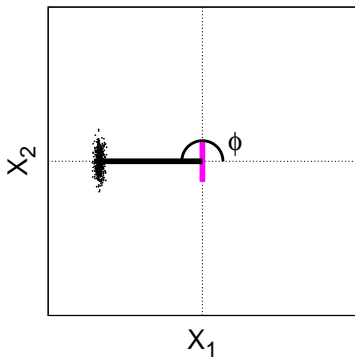

# Amplitude squeezed states

$$\Delta X_1 \Delta X_2 = 1/4$$

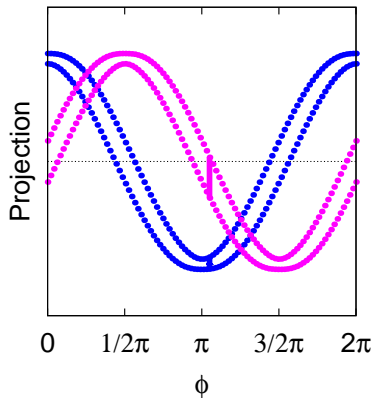
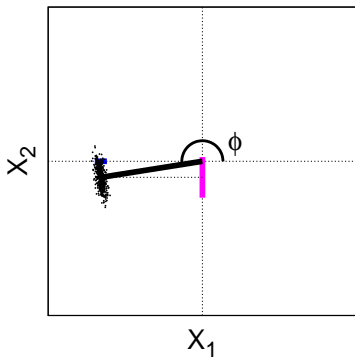

# Amplitude squeezed states

$$\Delta X_1 \Delta X_2 = 1/4$$

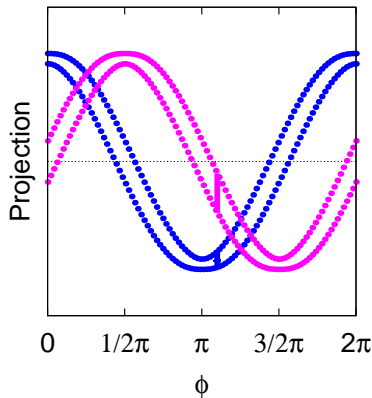
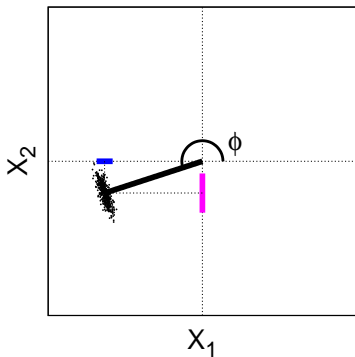

# Amplitude squeezed states

$$\Delta X_1 \Delta X_2 = 1/4$$

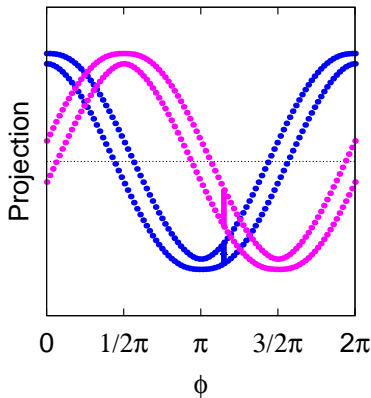
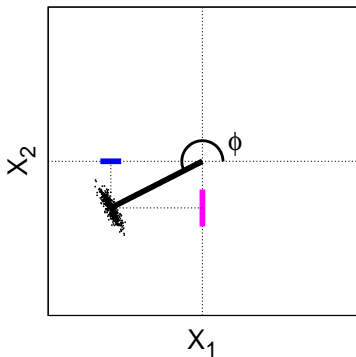

# Amplitude squeezed states

$$\Delta X_1 \Delta X_2 = 1/4$$

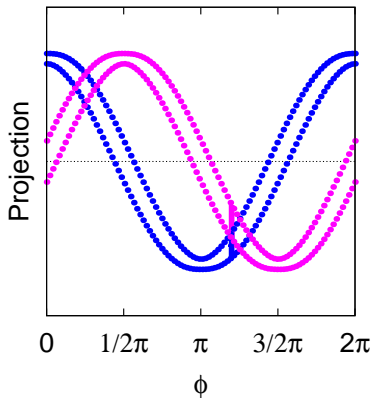
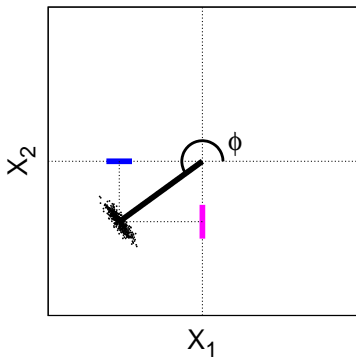

# Amplitude squeezed states

$$\Delta X_1 \Delta X_2 = 1/4$$

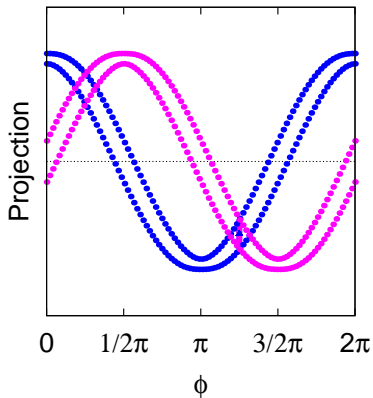
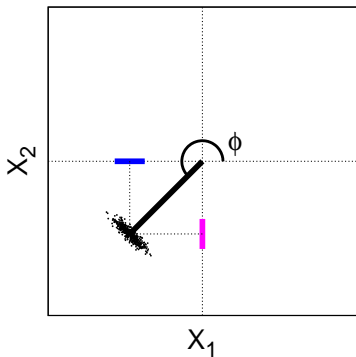

# Amplitude squeezed states

$$\Delta X_1 \Delta X_2 = 1/4$$

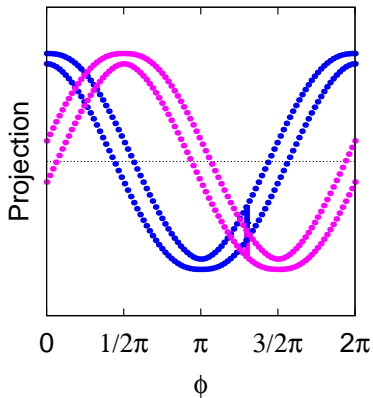
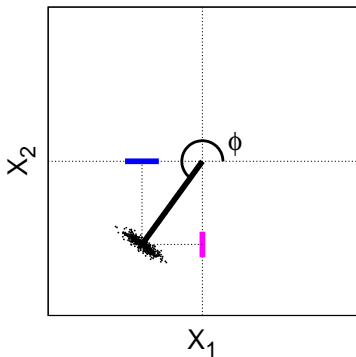



# Amplitude squeezed states

$$\Delta X_1 \Delta X_2 = 1/4$$

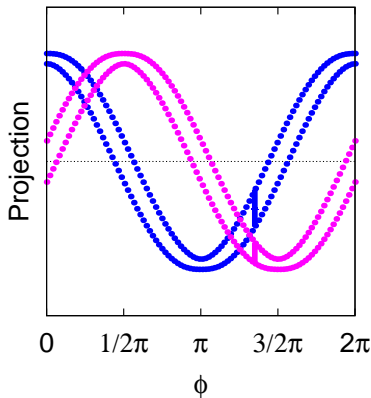
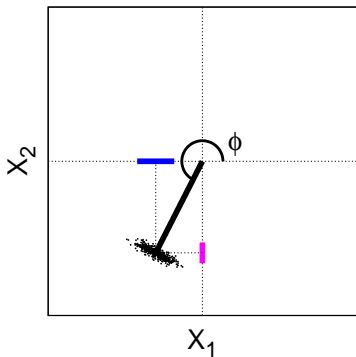

# Amplitude squeezed states

$$\Delta X_1 \Delta X_2 = 1/4$$

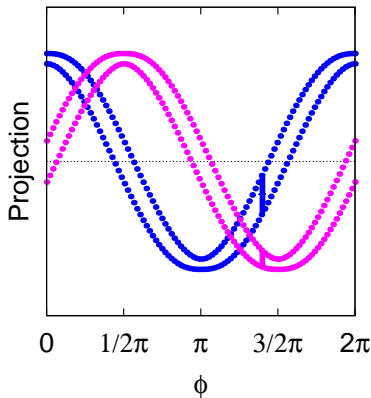
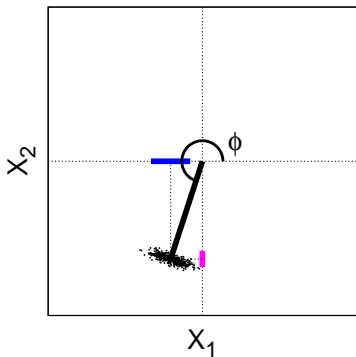

# Amplitude squeezed states

$$\Delta X_1 \Delta X_2 = 1/4$$

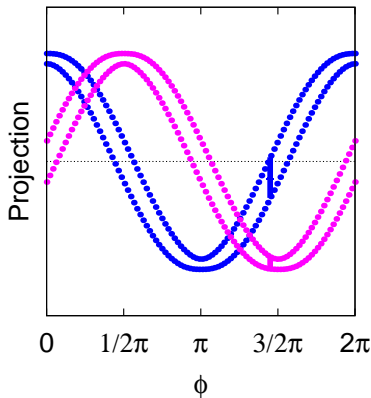
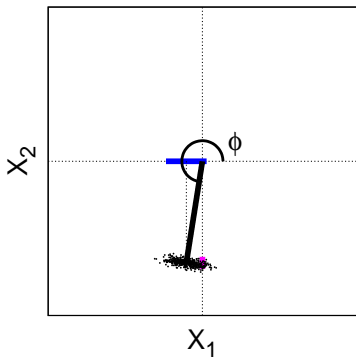

# Amplitude squeezed states

$$\Delta X_1 \Delta X_2 = 1/4$$

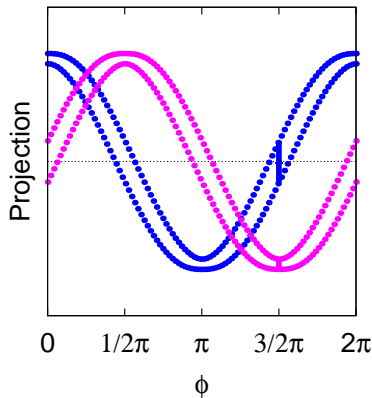
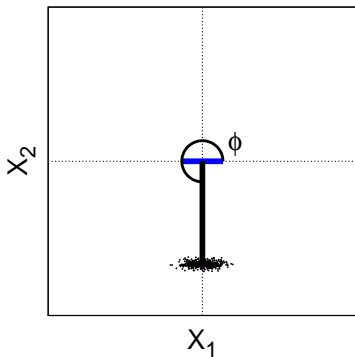

# Amplitude squeezed states

$$\Delta X_1 \Delta X_2 = 1/4$$

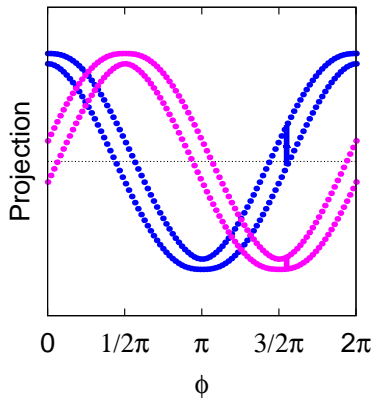
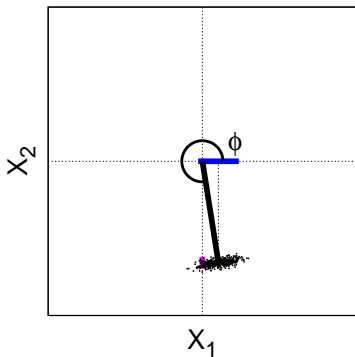

# Amplitude squeezed states

$$\Delta X_1 \Delta X_2 = 1/4$$

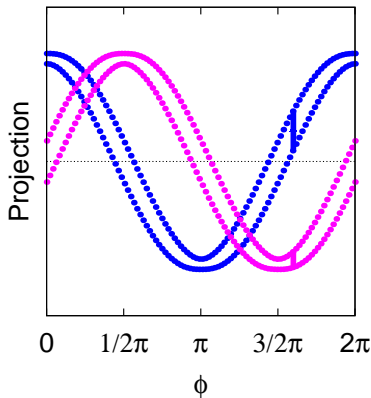
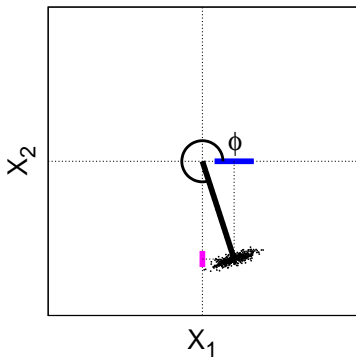

# Amplitude squeezed states

$$\Delta X_1 \Delta X_2 = 1/4$$

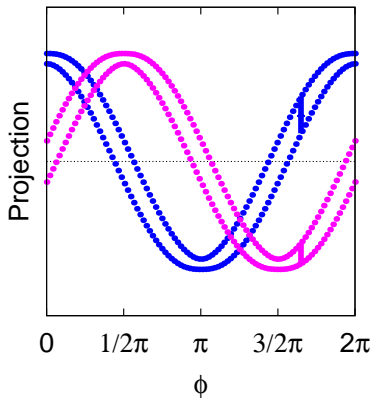
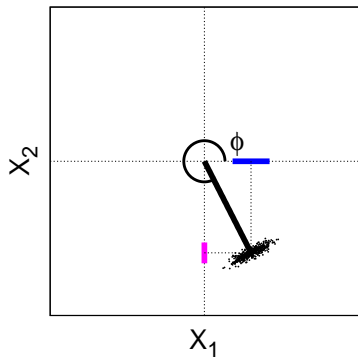

# Amplitude squeezed states

$$\Delta X_1 \Delta X_2 = 1/4$$

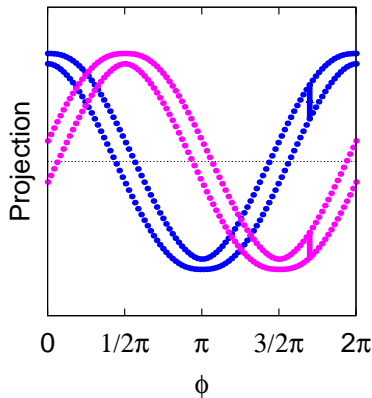
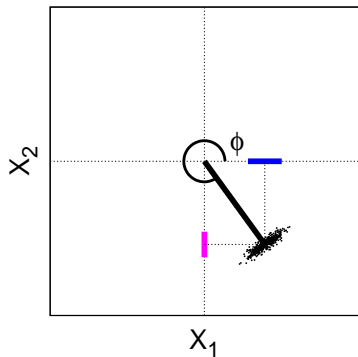



# Amplitude squeezed states

$$\Delta X_1 \Delta X_2 = 1/4$$

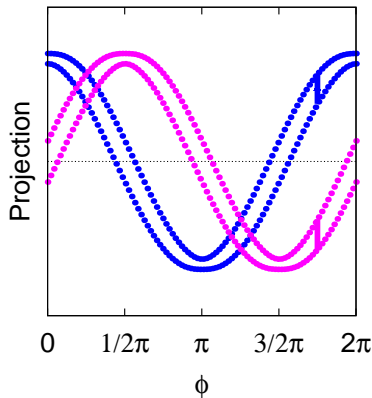
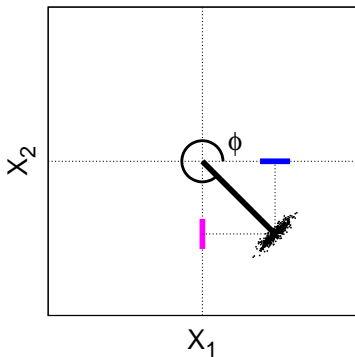

# Amplitude squeezed states

$$\Delta X_1 \Delta X_2 = 1/4$$

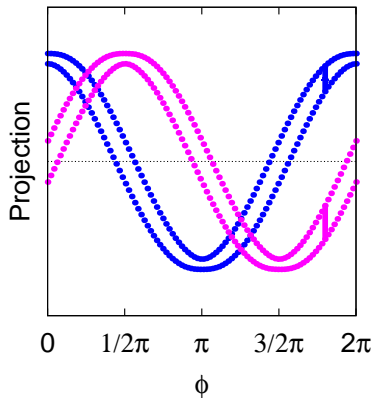
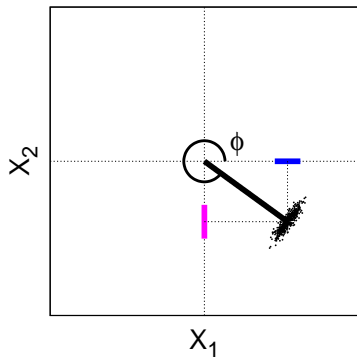

# Amplitude squeezed states

$$\Delta X_1 \Delta X_2 = 1/4$$

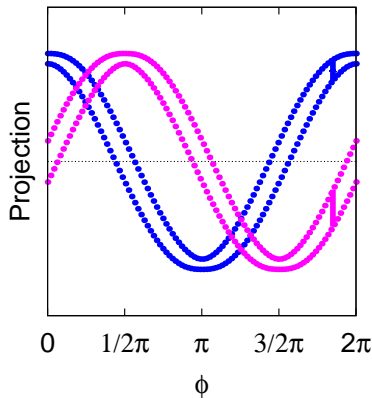
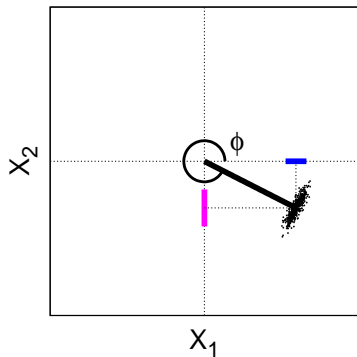

# Amplitude squeezed states

$$\Delta X_1 \Delta X_2 = 1/4$$

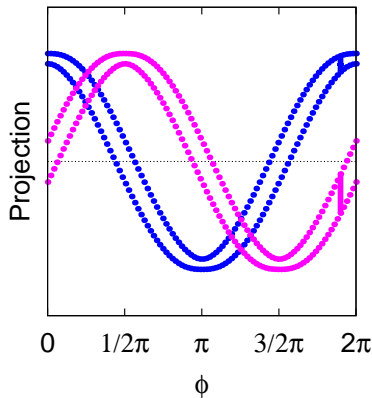
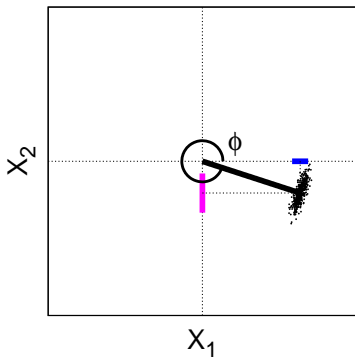

# Phase squeezed states

$$\Delta X_1 \Delta X_2 = 1/4$$

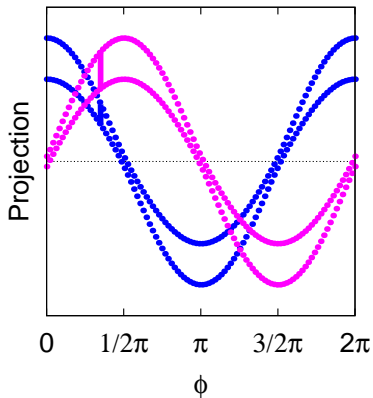
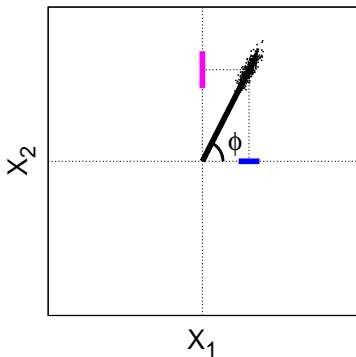

# Phase squeezed states

$$\Delta X_1 \Delta X_2 = 1/4$$

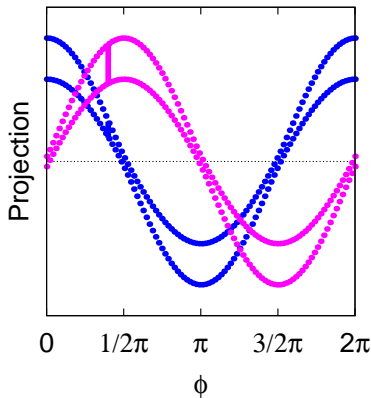
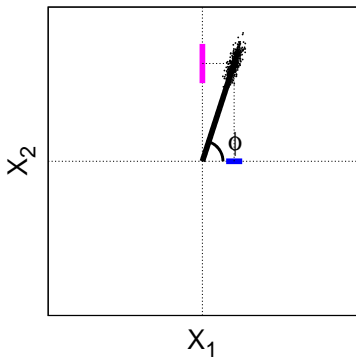

# Phase squeezed states

$$\Delta X_1 \Delta X_2 = 1/4$$

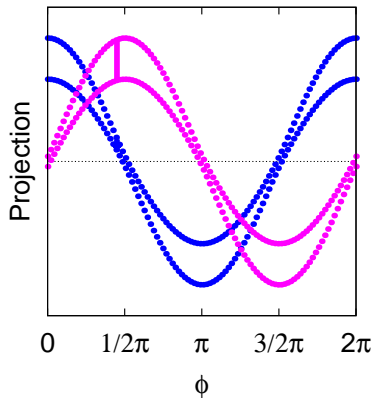
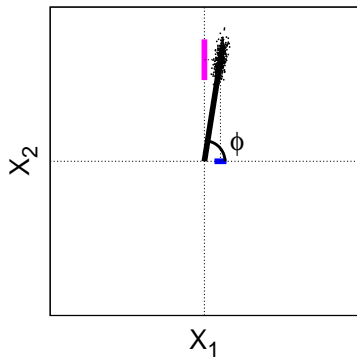

# Phase squeezed states

$$\Delta X_1 \Delta X_2 = 1/4$$

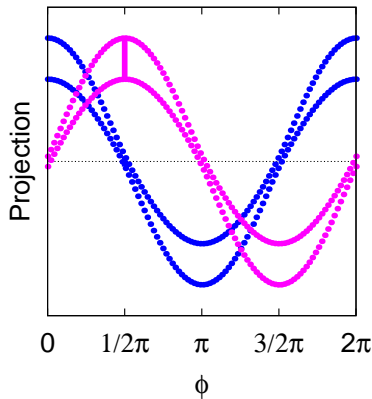
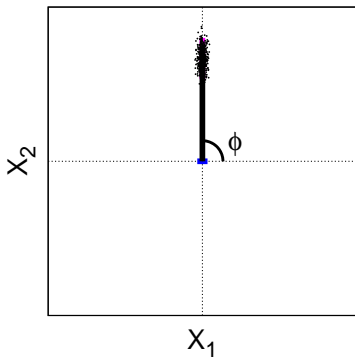



# Phase squeezed states

$$\Delta X_1 \Delta X_2 = 1/4$$

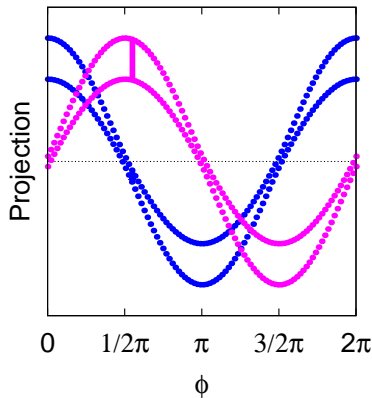
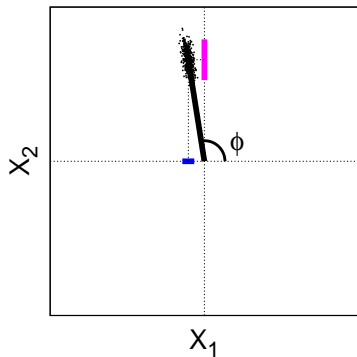

# Phase squeezed states

$$\Delta X_1 \Delta X_2 = 1/4$$

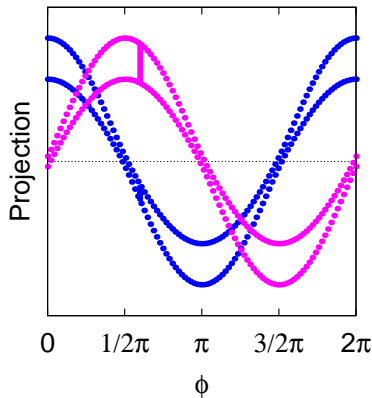
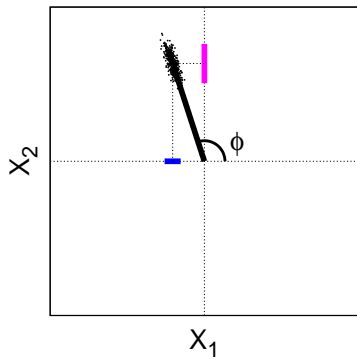

# Phase squeezed states

$$\Delta X_1 \Delta X_2 = 1/4$$

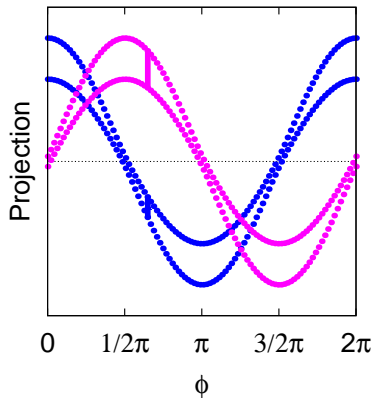
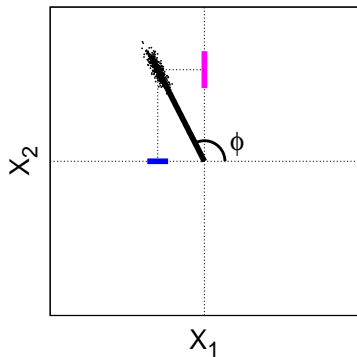

# Phase squeezed states

$$\Delta X_1 \Delta X_2 = 1/4$$

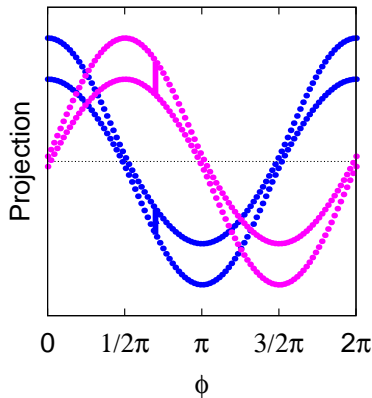
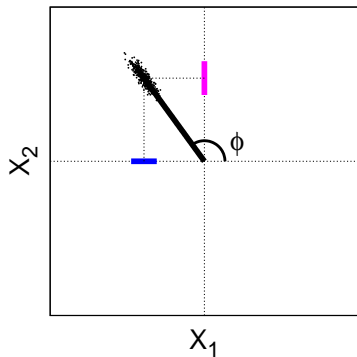

# Phase squeezed states

$$\Delta X_1 \Delta X_2 = 1/4$$

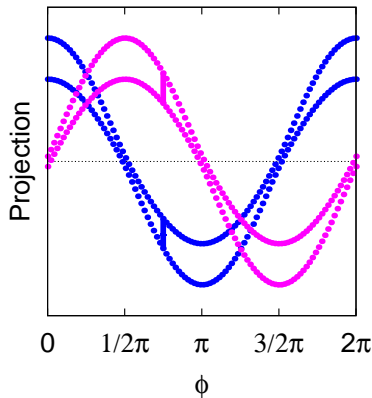
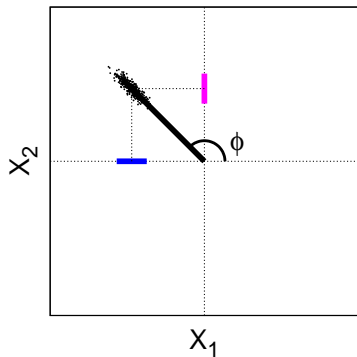

# Phase squeezed states

$$\Delta X_1 \Delta X_2 = 1/4$$

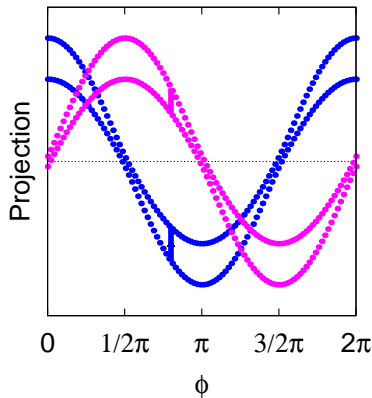
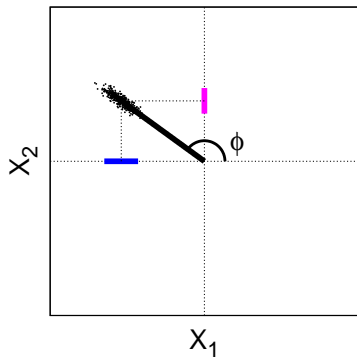

# Phase squeezed states

$$\Delta X_1 \Delta X_2 = 1/4$$

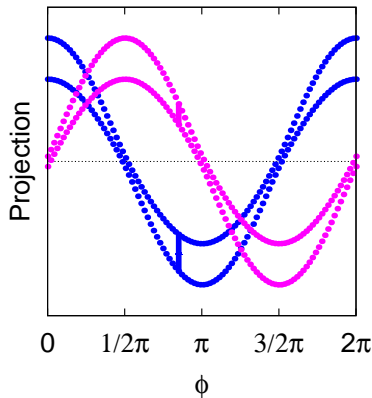
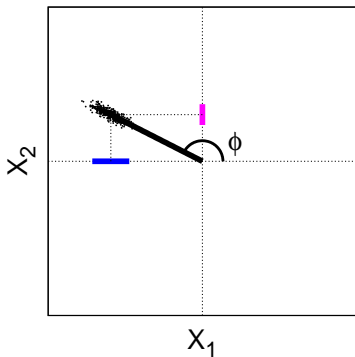

# Phase squeezed states

$$\Delta X_1 \Delta X_2 = 1/4$$

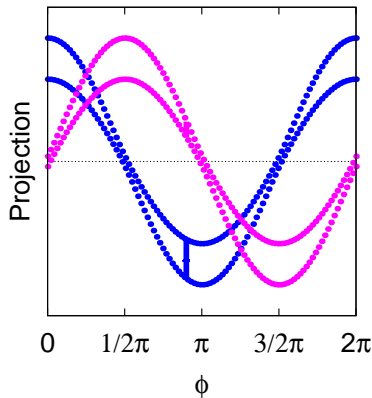
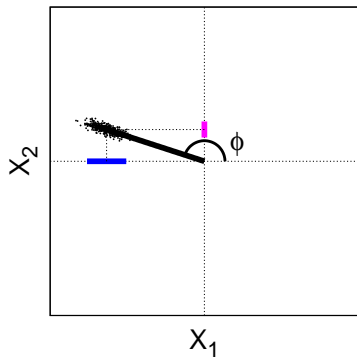



# Phase squeezed states

$$\Delta X_1 \Delta X_2 = 1/4$$

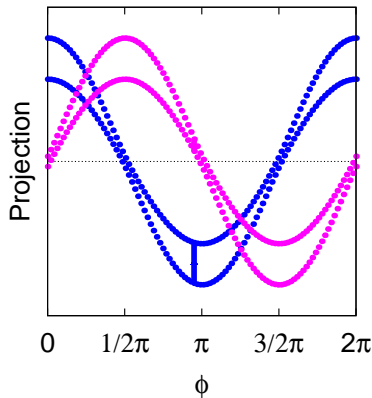
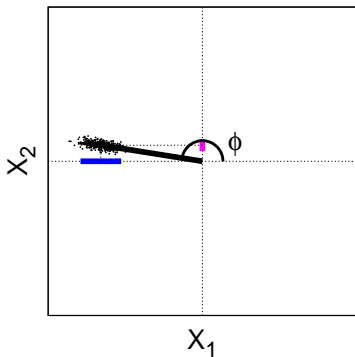

# Phase squeezed states

$$\Delta X_1 \Delta X_2 = 1/4$$

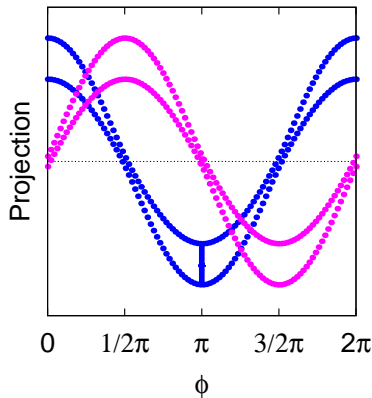
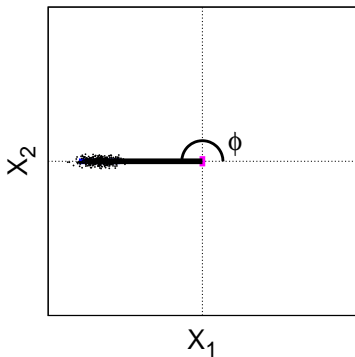

# Phase squeezed states

$$\Delta X_1 \Delta X_2 = 1/4$$

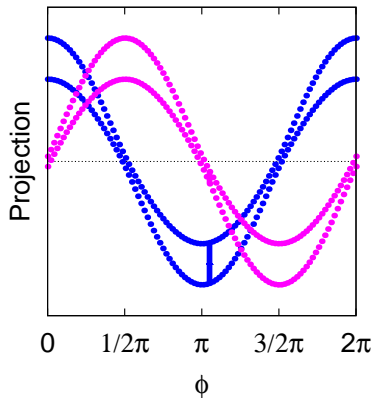
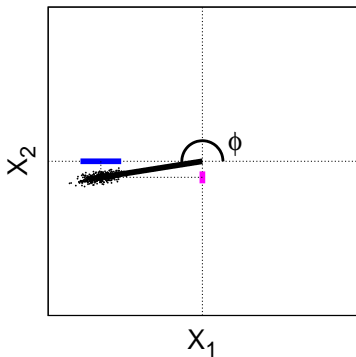

# Phase squeezed states

$$\Delta X_1 \Delta X_2 = 1/4$$

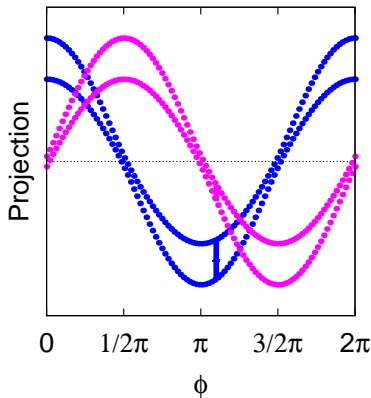
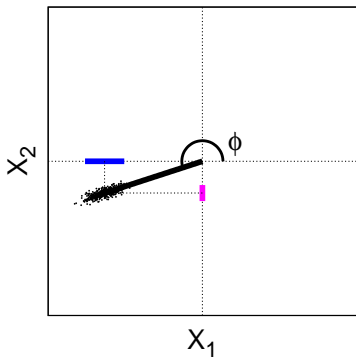

# Phase squeezed states

$$\Delta X_1 \Delta X_2 = 1/4$$

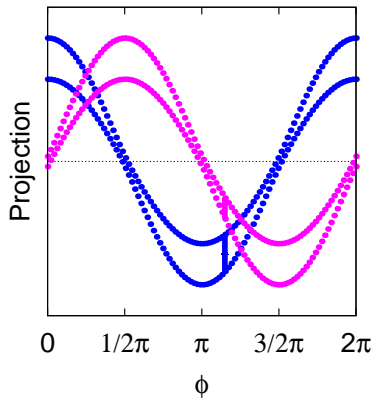
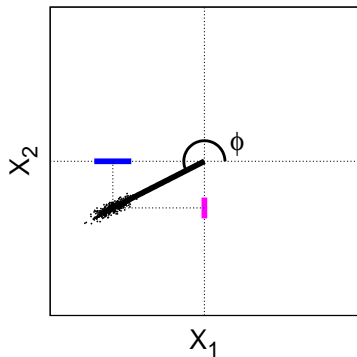

# Phase squeezed states

$$\Delta X_1 \Delta X_2 = 1/4$$

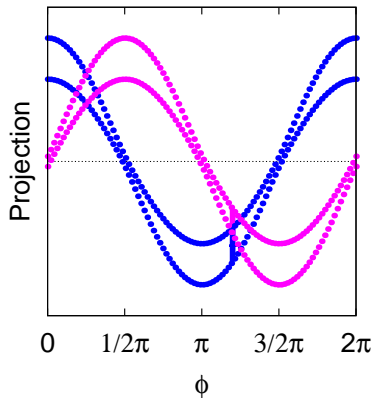
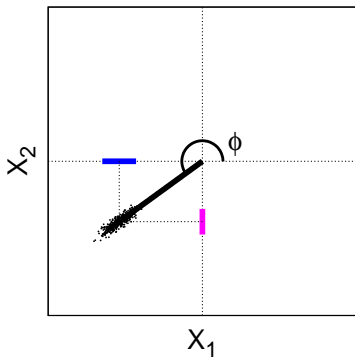

# Phase squeezed states

$$\Delta X_1 \Delta X_2 = 1/4$$

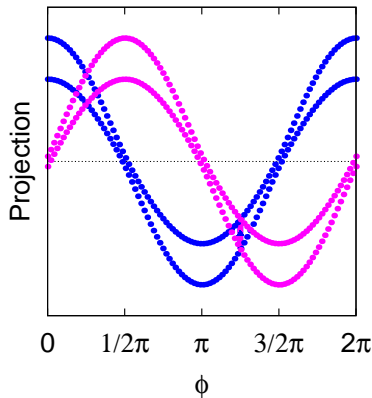
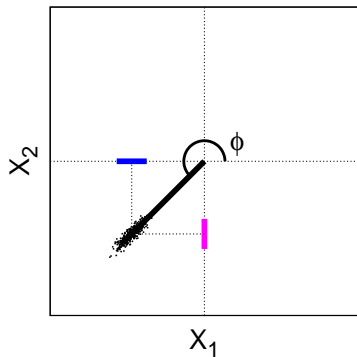

# Phase squeezed states

$$\Delta X_1 \Delta X_2 = 1/4$$

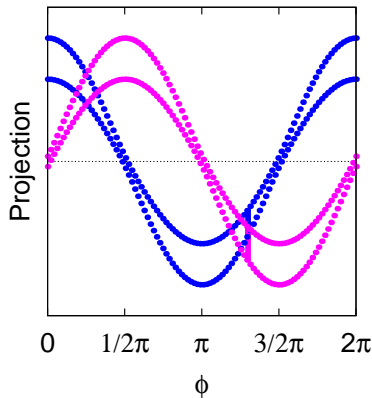
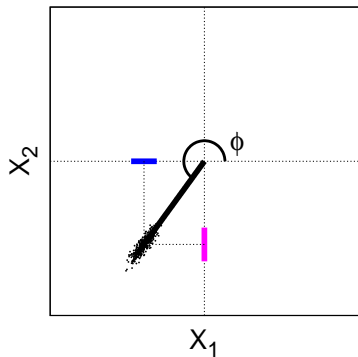



# Phase squeezed states

$$\Delta X_1 \Delta X_2 = 1/4$$

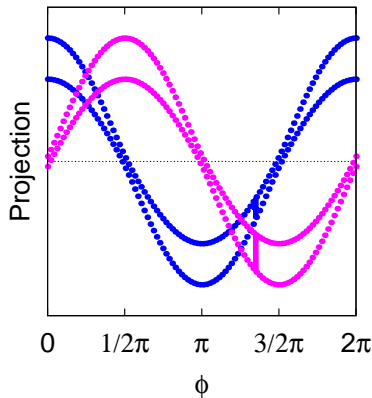
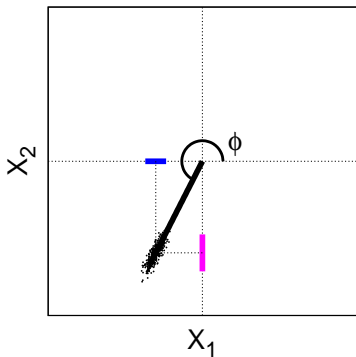

# Phase squeezed states

$$\Delta X_1 \Delta X_2 = 1/4$$

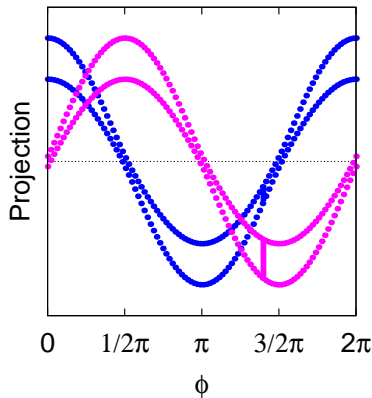
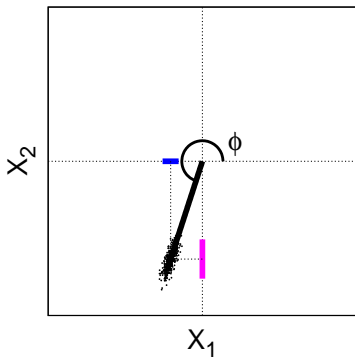

# Phase squeezed states

$$\Delta X_1 \Delta X_2 = 1/4$$

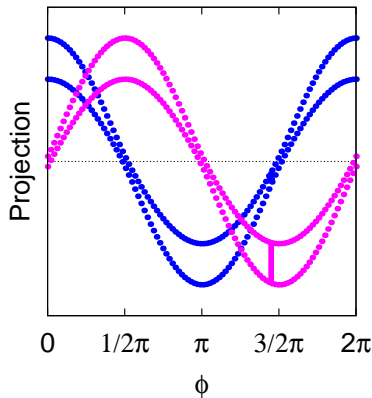
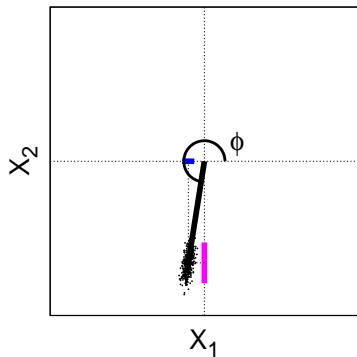

# Phase squeezed states

$$\Delta X_1 \Delta X_2 = 1/4$$

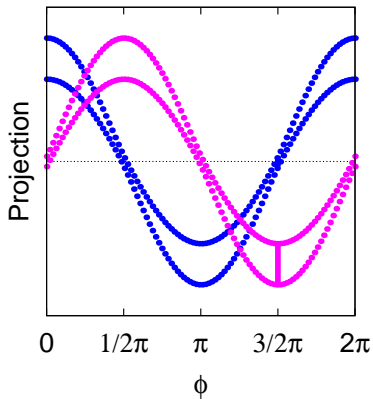
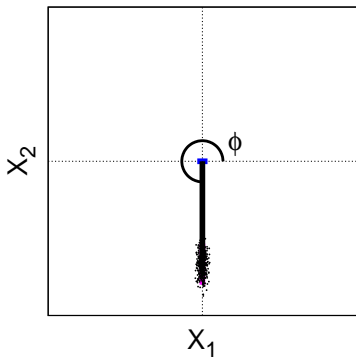

# Phase squeezed states

$$\Delta X_1 \Delta X_2 = 1/4$$

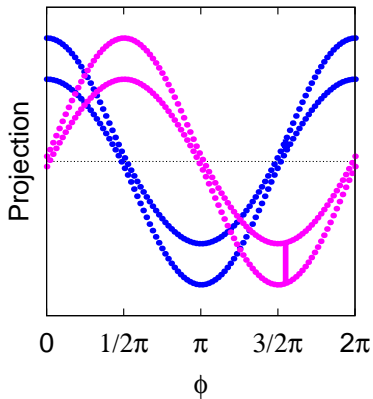
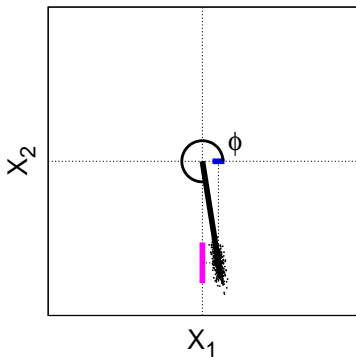

# Phase squeezed states

$$\Delta X_1 \Delta X_2 = 1/4$$

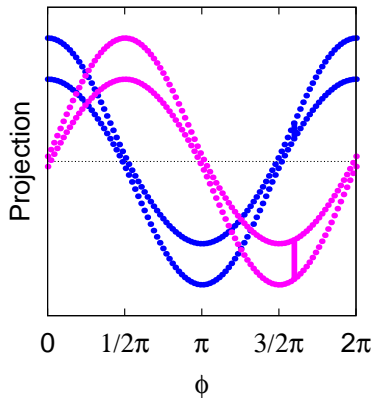
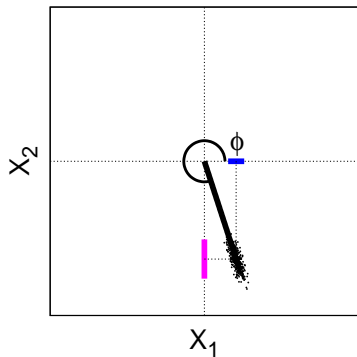

# Phase squeezed states

$$\Delta X_1 \Delta X_2 = 1/4$$

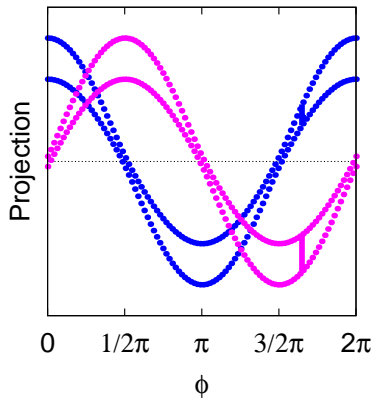
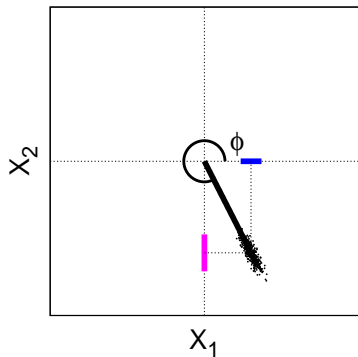

# Phase squeezed states

$$\Delta X_1 \Delta X_2 = 1/4$$

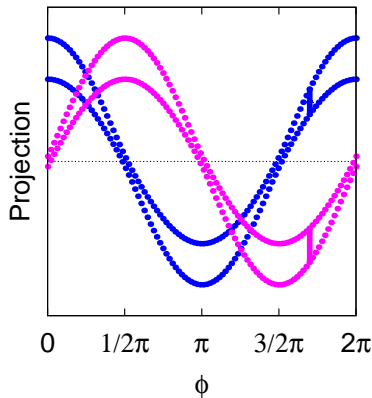
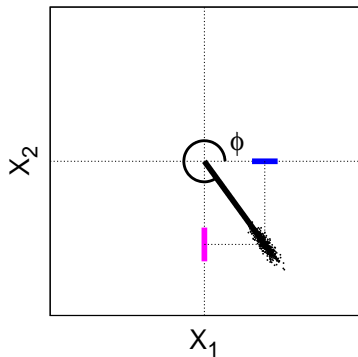



# Phase squeezed states

$$\Delta X_1 \Delta X_2 = 1/4$$

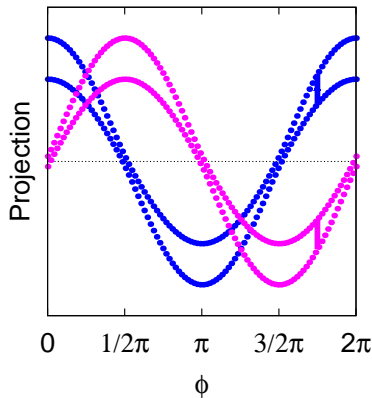
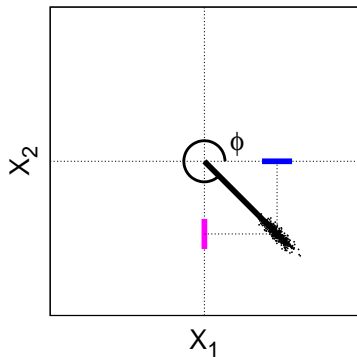

# Phase squeezed states

$$\Delta X_1 \Delta X_2 = 1/4$$

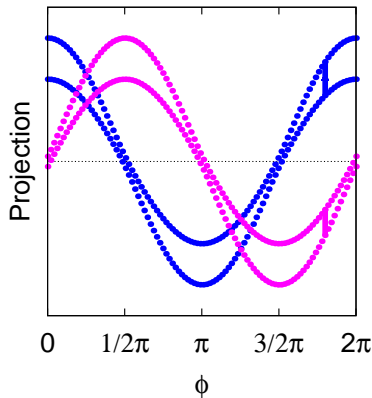
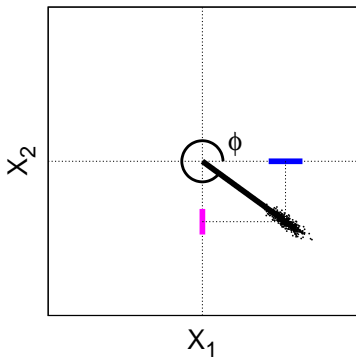

# Phase squeezed states

$$\Delta X_1 \Delta X_2 = 1/4$$

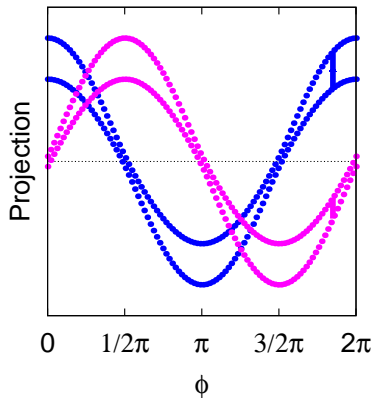
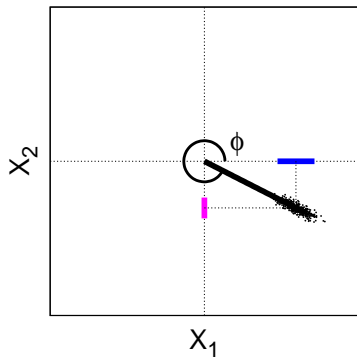

# Phase squeezed states

$$\Delta X_1 \Delta X_2 = 1/4$$

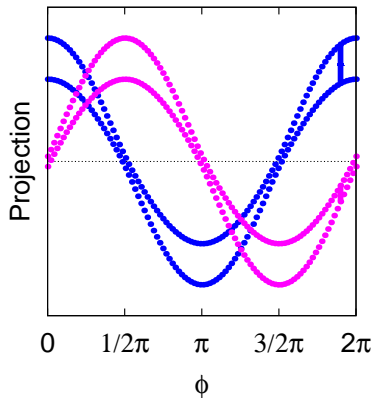
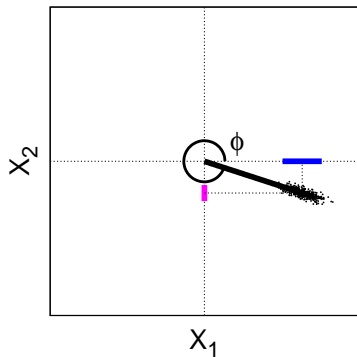

# Squeezed quantum states zoo

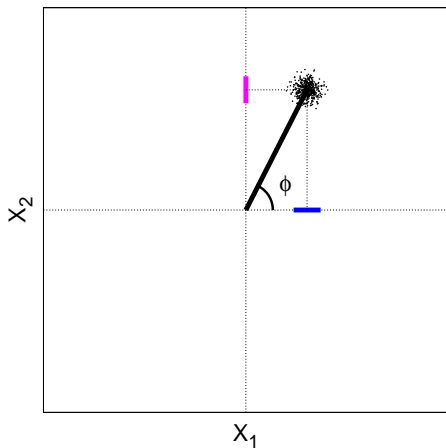

Unsqueezed  
coherent

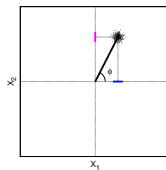

# Squeezed quantum states zoo

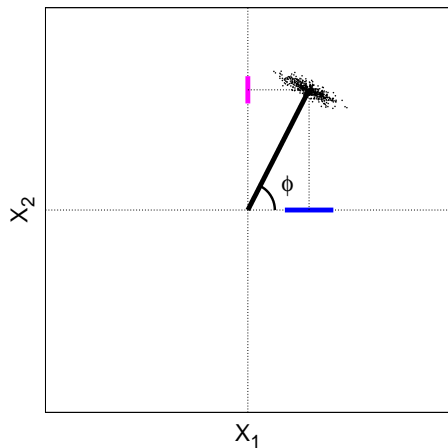

Unsqueezed  
coherent

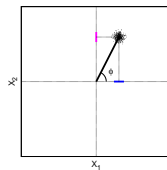

Amplitude  
squeezed

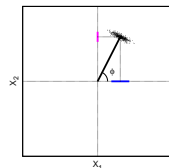

# Squeezed quantum states zoo

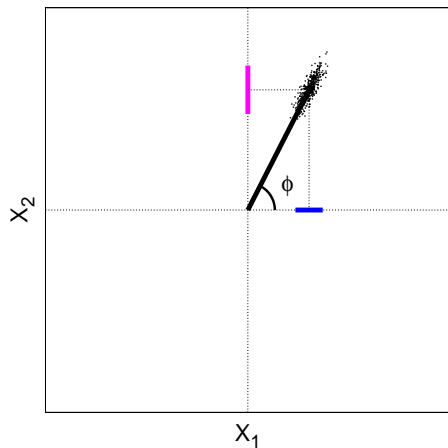

Unsqueezed  
coherent

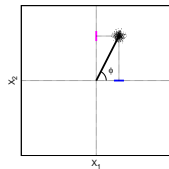

Amplitude  
squeezed

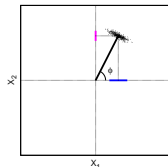

Phase  
squeezed

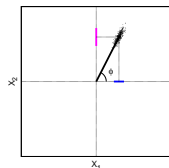

# Squeezed quantum states zoo

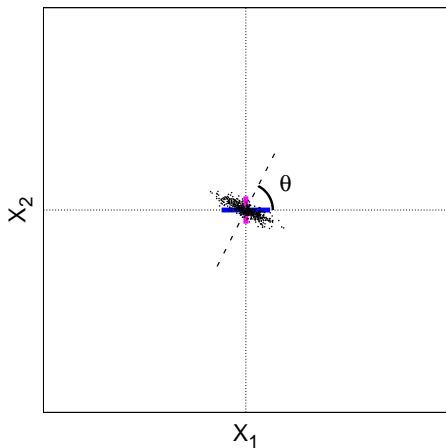

Unsqueezed  
coherent

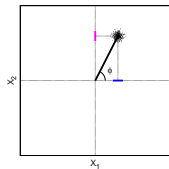

Amplitude  
squeezed

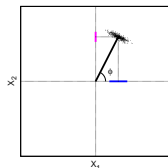

Phase  
squeezed

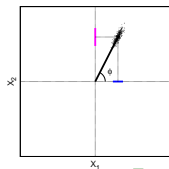

Vacuum  
squeezed

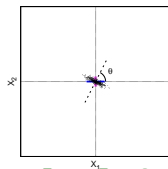



# Squeezed field generation recipe

Take a vacuum  
state  $|0\rangle$

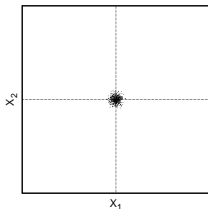

$$H = \frac{1}{2}$$

# Squeezed field generation recipe

Take a vacuum state  $|0\rangle$

Apply squeezing operator  $|\xi\rangle = \hat{S}(\xi)|0\rangle$

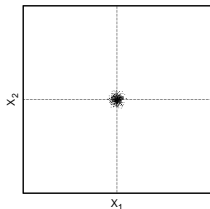

$$H = \frac{1}{2}$$

$$\hat{S}(\xi) = e^{\frac{1}{2}\xi^* a^2 - \frac{1}{2}\xi a^{\dagger 2}}$$

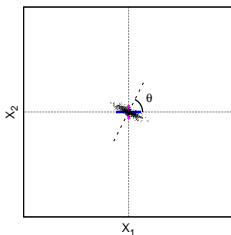

# Squeezed field generation recipe

Take a vacuum state  $|0\rangle$

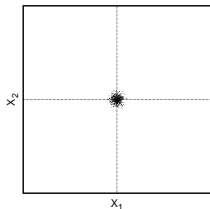

$$H = \frac{1}{2}$$

Apply squeezing operator  $|\xi\rangle = \hat{S}(\xi)|0\rangle$

$$\hat{S}(\xi) = e^{\frac{1}{2}\xi^* a^2 - \frac{1}{2}\xi a^{\dagger 2}}$$

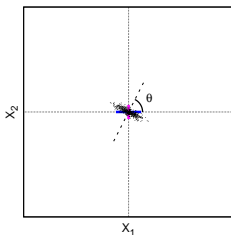

Apply displacement operator  $|\alpha, \xi\rangle = \hat{D}(\alpha)|s\rangle$

$$\hat{D}(\alpha) = e^{\alpha a^\dagger - \alpha^* a}$$

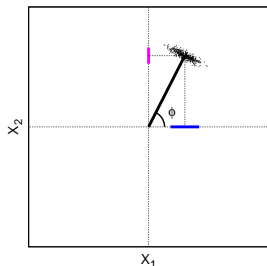

$$\begin{aligned}\langle \alpha, \xi | X_1 | \alpha, \xi \rangle &= \text{Re}(\alpha), \\ \langle \alpha, \xi | X_2 | \alpha, \xi \rangle &= \text{Im}(\alpha)\end{aligned}$$

# Squeezed field generation recipe

Take a vacuum state  $|0\rangle$

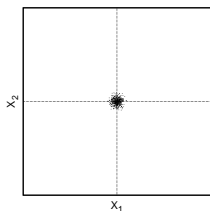

$$H = \frac{1}{2}$$

Apply squeezing operator  $|\xi\rangle = \hat{S}(\xi)|0\rangle$

$$\hat{S}(\xi) = e^{\frac{1}{2}\xi^* a^2 - \frac{1}{2}\xi a^{\dagger 2}}$$

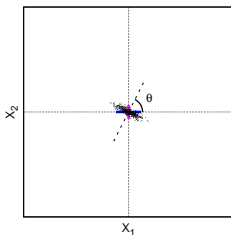

Apply displacement operator  $|\alpha, \xi\rangle = \hat{D}(\alpha)|\xi\rangle$

$$\hat{D}(\alpha) = e^{\alpha a^\dagger - \alpha^* a}$$

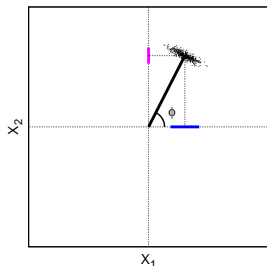

$$\langle \alpha, \xi | X_1 | \alpha, \xi \rangle = \text{Re}(\alpha),$$

$$\langle \alpha, \xi | X_2 | \alpha, \xi \rangle = \text{Im}(\alpha)$$

Notice  $\Delta X_1 \Delta X_2 = \frac{1}{4}$

# Squeezed state $|\xi\rangle = \hat{S}(\xi)|0\rangle$ properties

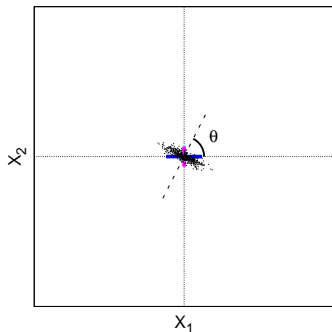

$$\hat{S}(\xi) = e^{\frac{1}{2}\xi^* a^2 - \frac{1}{2}\xi a^{\dagger 2}}, \xi = r e^{i\theta}$$

If  $\theta = 0$

$$\langle \xi | (\Delta X_1)^2 | \xi \rangle = \frac{1}{4} e^{-2r}$$

$$\langle \xi | (\Delta X_2)^2 | \xi \rangle = \frac{1}{4} e^{2r}$$

$$\langle \xi | (\Delta X_1)^2 | \xi \rangle = \frac{1}{4} (\cosh^2 r + \sinh^2 r - 2 \sinh r \cosh r \cos \theta)$$

$$\langle \xi | (\Delta X_2)^2 | \xi \rangle = \frac{1}{4} (\cosh^2 r + \sinh^2 r + 2 \sinh r \cosh r \cos \theta)$$

# Photon number of squeezed state $|\xi\rangle$

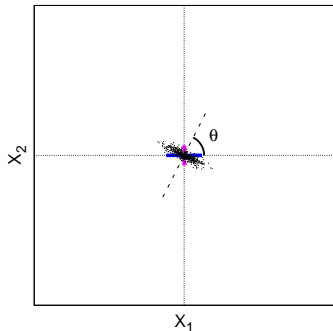

Probability to detect given number of photons  $C = \langle n | \xi \rangle$  for squeezed vacuum

- even

$$C_{2m} = (-1)^m \frac{\sqrt{(2m)!}}{2^m m!} \frac{(e^{i\theta} \tanh r)^m}{\sqrt{\cosh r}}$$

- odd

$$C_{2m+1} = 0$$

Average number of photons in general squeezed state

$$\langle \alpha, \xi | a^\dagger a | \alpha, \xi \rangle = \alpha + \sinh^2 r$$

# Tools for squeezing

# Tools for squeezing

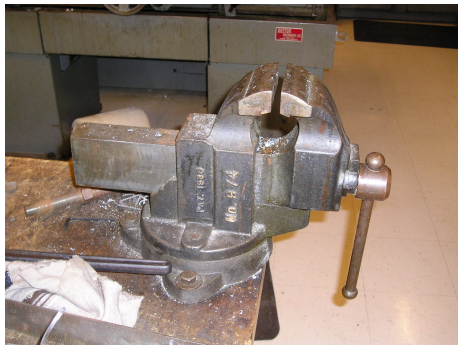



# Tools for squeezing

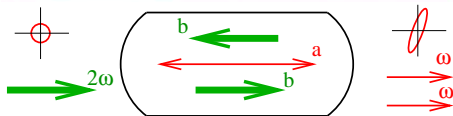
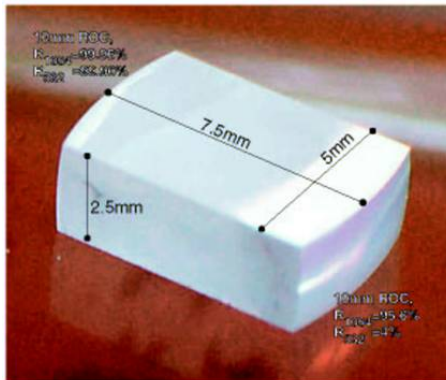
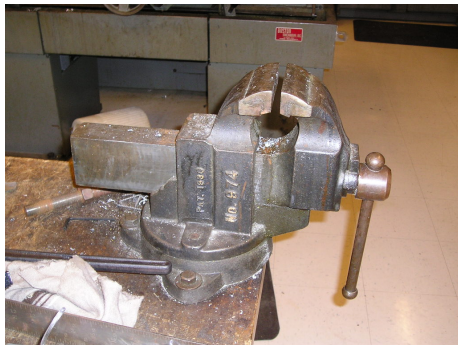

# Two photon squeezing picture

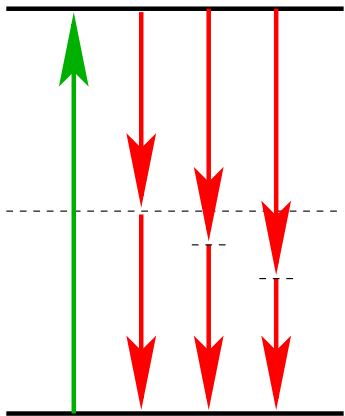

Squeezing operator

$$\hat{S}(\xi) = e^{\frac{1}{2}\xi^* a^2 - \frac{1}{2}\xi a^{\dagger 2}}$$

Parametric down-conversion in crystal

$$\hat{H} = i\hbar\chi^{(2)}(a^2 b^\dagger - a^{\dagger 2} b)$$

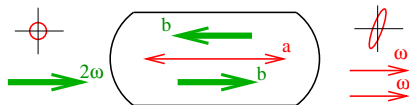

Squeezing

result of correlation of upper and lower sidebands

# Squeezer appearance

# Squeezer appearance

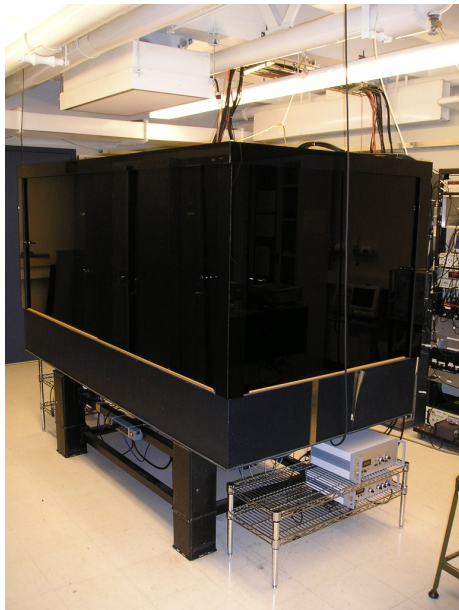

# Squeezer appearance

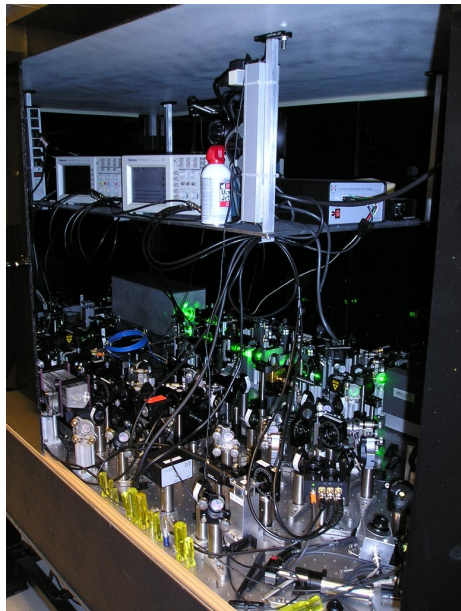
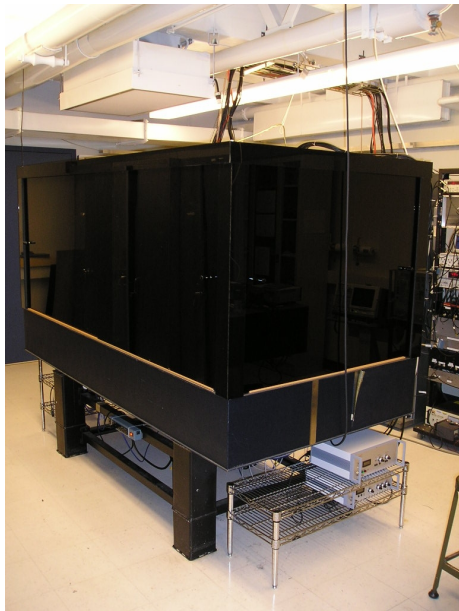

# Crystal squeezing setup scheme

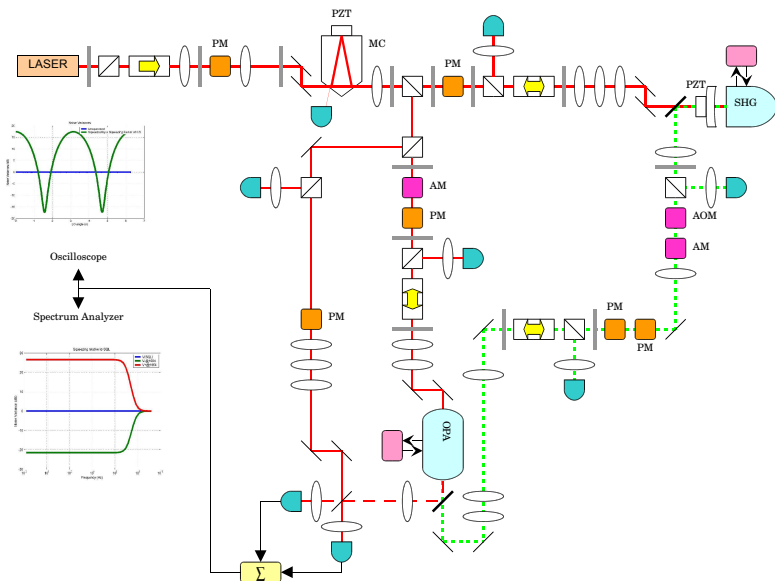

# Possible squeezing applications

- improvements any shot noise limited optical sensors
- noise less signal amplification
- secure communications (you would notice eavesdropper)
- photon pair generation, entanglement, true single photon sources
- quantum memory probe and information carrier
- interferometers sensitivity boost (for example gravitational wave antennas)
- light free measurements

# Squeezing and interferometer



# Squeezing and interferometer

Vacuum input

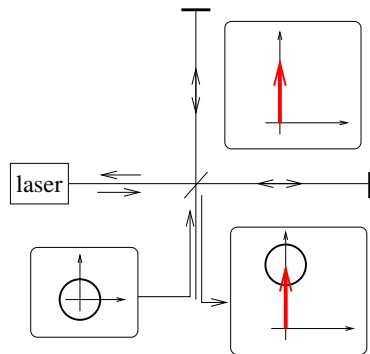

# Squeezing and interferometer

Vacuum input

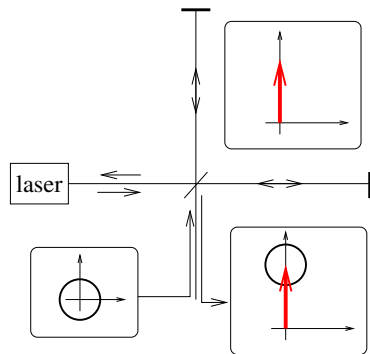

Squeezed input

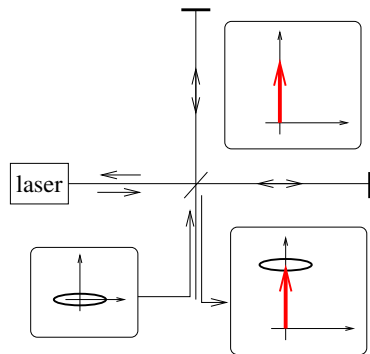

# Laser Interferometer Gravitational-wave Observatory



- $L = 4 \text{ km}$
- $h \sim 10^{-21}$
- $\Delta L \sim 10^{-18} \text{ m}$
- $\Delta \phi \sim 10^{-10} \text{ rad}$

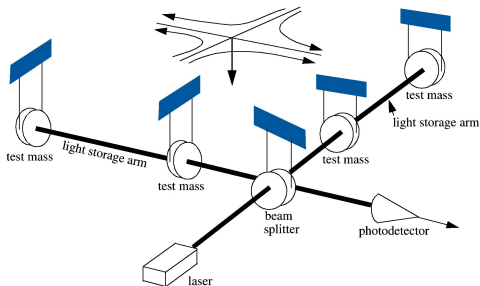

# Interferometer sensitivity improvement with squeezing

Table top demonstration

Pioneered by M. Xiao, L. Wu,  
and H. J. Kimble

Phys. Rev. Lett. 59, 278-281 (1987)

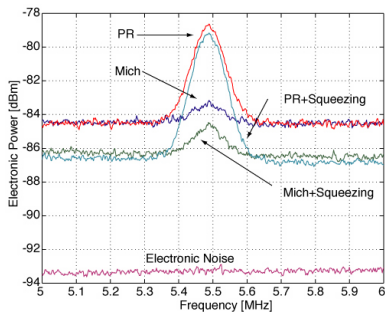

Kirk McKenzie *et. al.*  
Phys. Rev. Lett. 88, 231102 (2002)  
The Australian National University

Projected  
advanced LIGO sensitivity

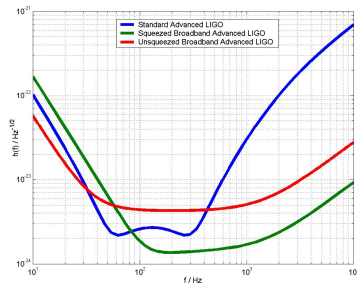

T. Corbitt *et.al.*  
Phys. Rev. D 70, 022002  
(2004) MIT

# Requirements to squeezer

- squeezing at low frequency (10Hz - 10kHz)
- frequency dependent quadrature (angle) of squeezing
- stability (long time of operation)

# Squeezing level vs time (unlocked)

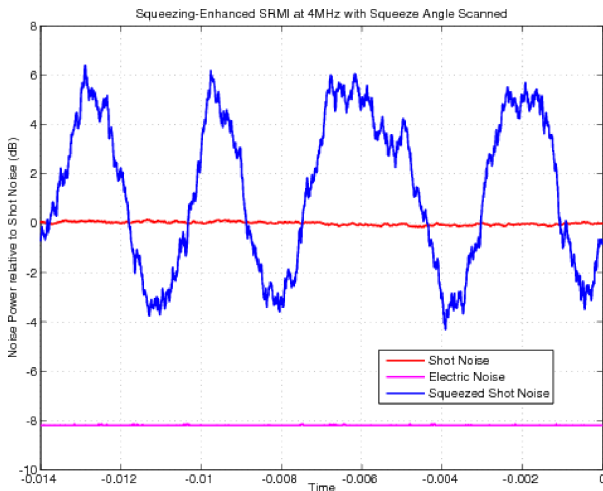

“A quantum-enhanced prototype gravitational-wave detector”,  
Nature Physics, **4**, 472-476, (2008).

# GW 40m detector and squeezer

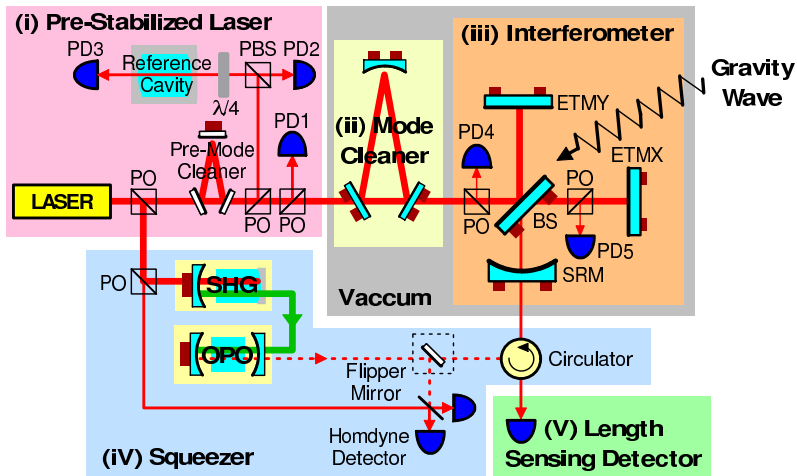

# GW 40m detector with 4dB of squeezed vacuum

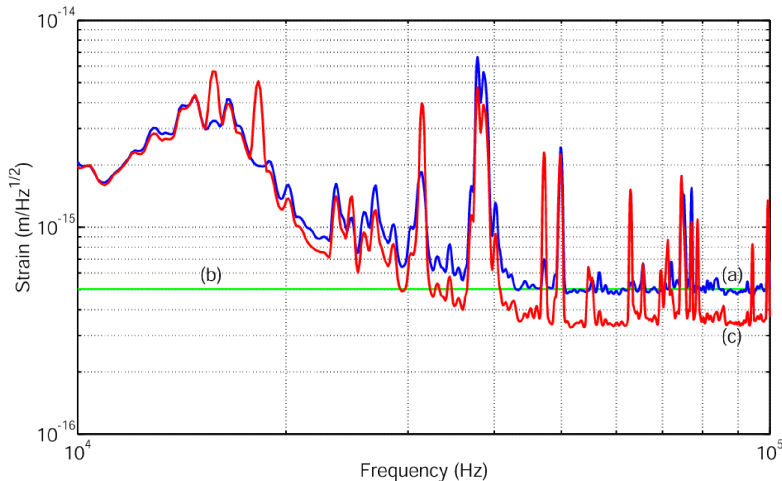

Signal to noise improvement by factor of 1.43



# Cavity parameters with squeezing

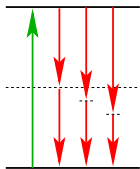

# Cavity parameters with squeezing

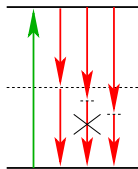
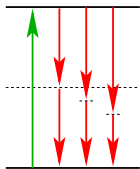

# Cavity parameters with squeezing

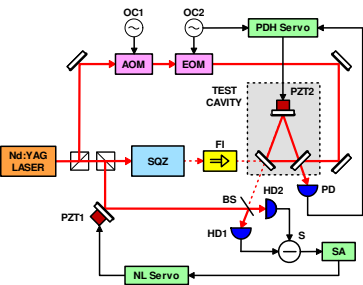
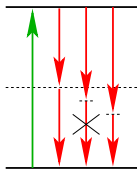
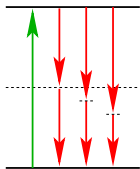

# Cavity parameters with squeezing

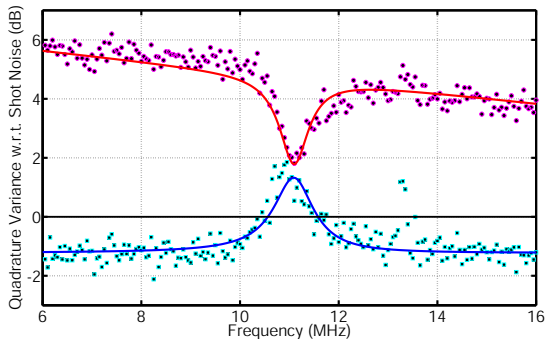
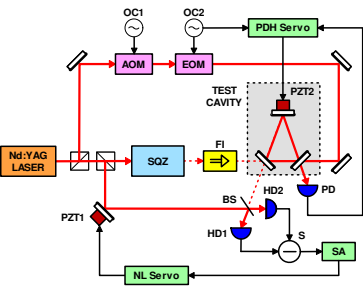
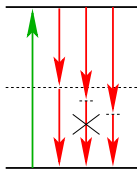
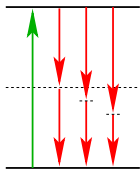

“Noninvasive measurements of cavity parameters by use of squeezed vacuum”, *Physical Review A*, **74**, 033817, (2006).

# Low frequency squeezing with light free noise lock

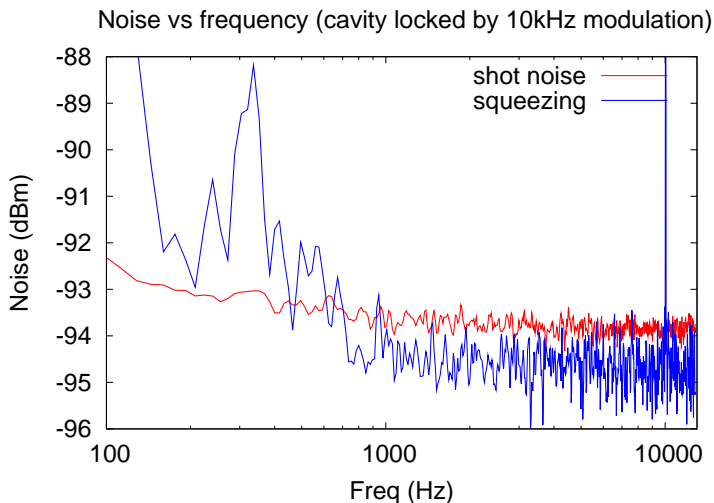

“Quantum noise locking”,  
J. Opt. B: Quantum Semiclass. Opt., 7, S421, (2005).

# Squeezing level vs time (homodyne angle lock is on)

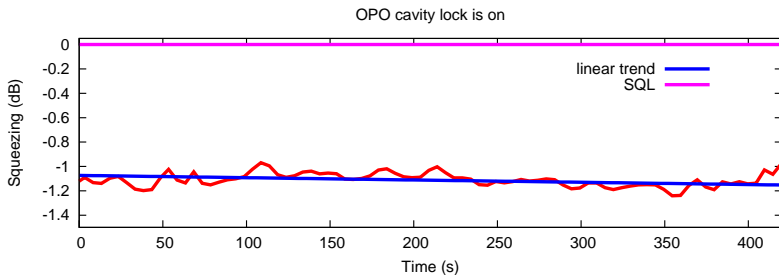
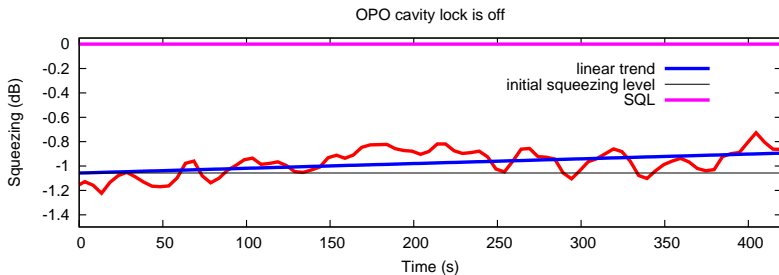

# Summary for crystal squeezing

## Pros

- mainstream: many different nonlinear crystals available
- so far the best squeezers
  - maximum squeezing value detected **11.5 dB at 1064 nm**
  - Moritz Mehmet, Henning Vahlbruch, Nico Lastzka, Karsten Danzmann, and Roman Schnabel, "Observation of squeezed states with strong photon-number oscillations", Phys. Rev. A **81**, 013814 (2010)
- well understood

## Cons

- crystals have limited transparency window
- thus squeezing is hard to generate at visible wavelength
  - at 795 nm only 4-6 dB squeezing is reported
- this limits such squeezer for spectroscopy applications

# Quantum memory with atomic ensembles

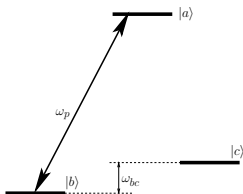
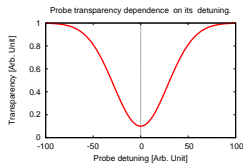

## Storage and retrieval

- single photon
- squeezed state (Furusawa and Lvovsky PRL **100** 2008)

## Squeezed state requirements

- squeezing carrier at atomic wavelength (780nm, 795nm)
- squeezing within narrow resonance window at frequencies ( $< 100\text{kHz}$ )

Nonlinear crystal based squeezers are capable of it, but they are **extremely technically challenging** especially at short wave length.



# Quantum memory with atomic ensembles

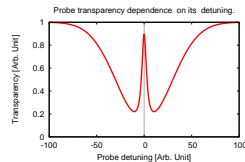
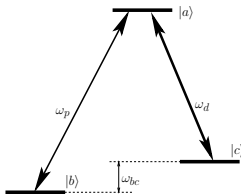
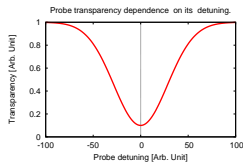

## Storage and retrieval

- single photon
- squeezed state (Furusawa and Lvovsky PRL **100** 2008)

## Squeezed state requirements

- squeezing carrier at atomic wavelength (780nm, 795nm)
- squeezing within narrow resonance window at frequencies ( $< 100\text{kHz}$ )

Nonlinear crystal based squeezers are capable of it, but they are **extremely technically challenging** especially at short wave length.

# Self-rotation of elliptical polarization in atomic medium

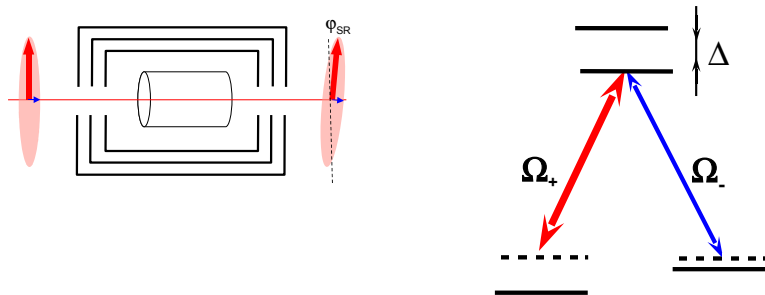

A.B. Matsko et al., PRA 66, 043815 (2002): theoretically prediction of 4-6 dB noise suppression

$$a_{out} = a_{in} + \frac{igL}{2}(a_{in}^{\dagger} - a_{in}) \quad (2)$$

# Will something so simple work?

- **Yes!** J. Ries, B. Brezger, and A. I. Lvovsky, Experimental vacuum squeezing in rubidium vapor via self-rotation, PRA **68**, 025801 (2003).
  - Observed 0.85dB of squeezing at bandwidth 5-10MHz

# Will something so simple work?

- **Yes!** J. Ries, B. Brezger, and A. I. Lvovsky, Experimental vacuum squeezing in rubidium vapor via self-rotation, PRA **68**, 025801 (2003).
  - Observed 0.85dB of squeezing at bandwidth 5-10MHz
- **No!** M. T. L. Hsu et al., Effect of atomic noise on optical squeezing via polarization self-rotation in a thermal vapor cell, PRA **73**, 023806 (2006).
  - Observed 6dB of excess noise after the cell

# Will something so simple work?

- **Yes!** J. Ries, B. Brezger, and A. I. Lvovsky, Experimental vacuum squeezing in rubidium vapor via self-rotation, PRA **68**, 025801 (2003).
  - Observed 0.85dB of squeezing at bandwidth 5-10MHz
- **No!** M. T. L. Hsu et al., Effect of atomic noise on optical squeezing via polarization self-rotation in a thermal vapor cell, PRA **73**, 023806 (2006).
  - Observed 6dB of excess noise after the cell
- **Possible.** A. Lezama et al., PRA **77**, 013806 (2008).

# Setup

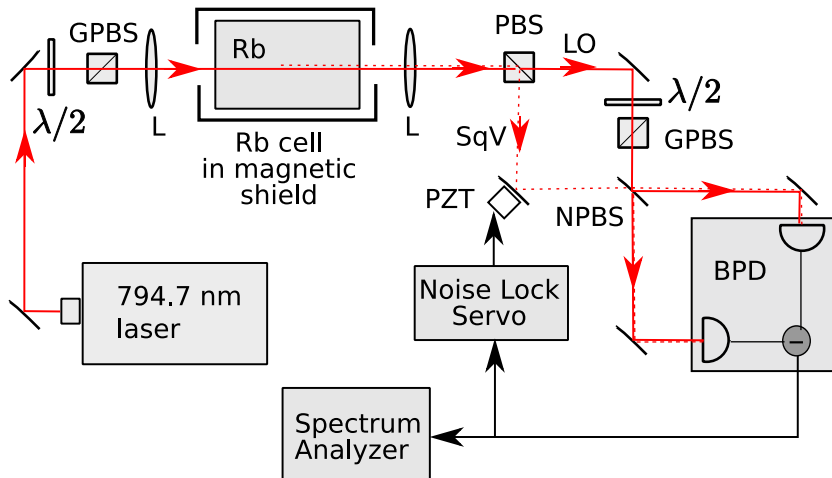

# Low frequency squeezing vs power in $^{87}\text{Rb}$ at 795 nm

$^{87}\text{Rb}$  cell + 2.5Torr Ne,  $T=63.3^\circ\text{C}$   $P=1.5$  mW

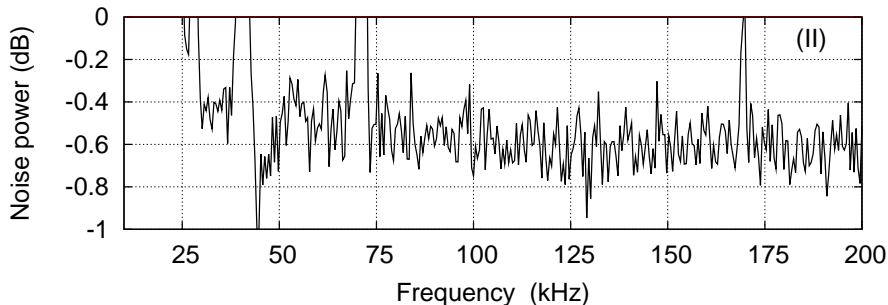

Eugeniy E. Mikhailov, Irina Novikova: Optics Letters, Issue 11, 33, 1213-1215, (2008).

# Low frequency squeezing vs detuning in $^{87}\text{Rb}$ at 795 nm

$^{87}\text{Rb}$  cell + 2.5Torr Ne,  $T=63.3^\circ\text{C}$

(a)  $P=1.0$  mW, (b)  $P=1.5$  mW, (c)  $P=4.2$  mW, (d)  $P=6.6$  mW

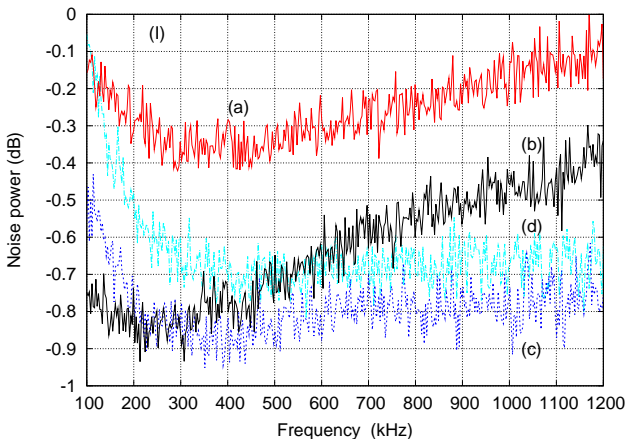



# Squeezing region

## Squeezing

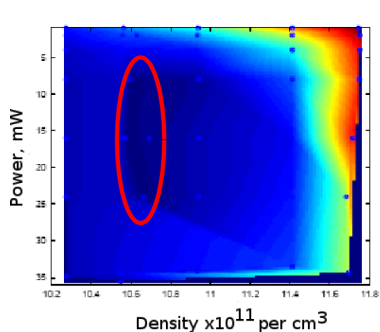

## Anti-squeezing

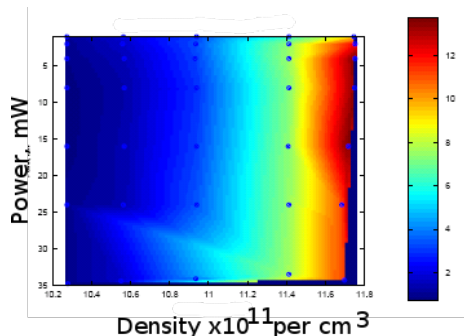

Observation of reduction of quantum noise below the shot noise limit is corrupted by the excess noise due to atomic interaction with atoms.

# Squeezing theory and experiment

- $^{87}\text{Rb}$  cell
- no buffer gas
- density  $2 \cdot 10^{11} \text{ cm}^{-3}$
- laser power 6 mW
- beam size 0.2 mm

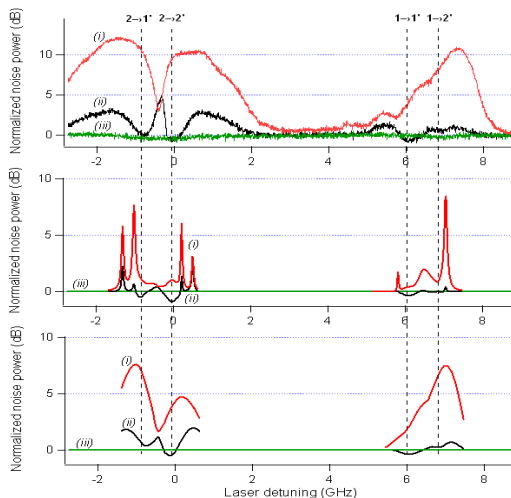

E.E. Mikhailov, A. Lezama, T. Noel and I. Novikova,  
J. Mod. Opt. **56**, 1985 (2009).



Support from



# Summary

- Squeezing is exiting
- many applications benefit from squeezing
- there is still a lot of interesting physics to do