

# Quantum mechanics of a beam splitter

Beam splitter is a device to divide (or combine) optical fields

## Classical beam splitter

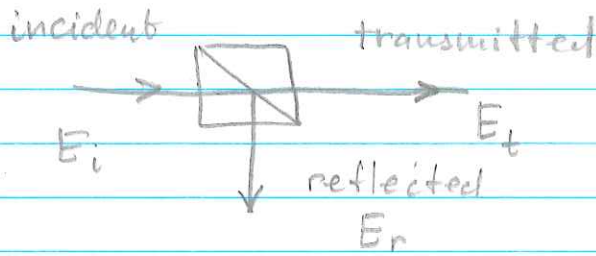

$$E_t = t E_i$$

$$E_r = r E_i$$

$$|t|^2 + |r|^2 = 1$$

energy conservation

Quantum  $E \rightarrow \hat{a}$   
assumption

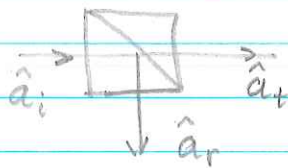

$$\hat{a}_t = t \hat{a}_i$$

$$\hat{a}_r = r \hat{a}_i$$

(?)

$$[\hat{a}_t, \hat{a}_t^\dagger] = [t \hat{a}_i, t^* \hat{a}_i^\dagger] = |t|^2 [\hat{a}_i, \hat{a}_i^\dagger] = |t|^2 \leq 1 \quad \underline{???}$$

Our assumption is not correct  $\rightarrow$   
we forgot the fourth port!

In classical treatment vacuum is neglectable. In quantum treatment vacuum is an active participant!

More accurate picture

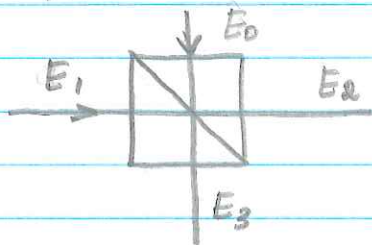

$E_1$	$E_0$
$E_2$	$r$
$E_3$	$t$

 differences b/w  $(r, t)$  and  $(r', t')$  reflect possible phase differences

$$\begin{aligned} E_2 &= tE_1 + r'E_0 \\ E_3 &= rE_1 + t'E_0 \end{aligned} \Rightarrow \begin{pmatrix} E_2 \\ E_3 \end{pmatrix} = \begin{pmatrix} t' & r \\ r' & t \end{pmatrix} \begin{pmatrix} E_0 \\ E_1 \end{pmatrix}$$

Assuming now  $E_i \rightarrow \hat{a}_i$

$$\begin{pmatrix} \hat{a}_2 \\ \hat{a}_3 \end{pmatrix} = \begin{pmatrix} t' & r \\ r' & t \end{pmatrix} \begin{pmatrix} \hat{a}_0 \\ \hat{a}_1 \end{pmatrix}$$

Checking the commutation relationships

$$\begin{aligned} [\hat{a}_2, \hat{a}_2^\dagger] &= [t'\hat{a}_0 + r\hat{a}_1, t'^*\hat{a}_0^\dagger + r^*\hat{a}_1^\dagger] = \\ &= |t'|^2 [\hat{a}_0, \hat{a}_0^\dagger] + |r|^2 [\hat{a}_1, \hat{a}_1^\dagger] = |t'|^2 + |r|^2 = 1 \end{aligned}$$

If  $|t'| = |t|, |r'| = |r|$

$$\begin{aligned} [\hat{a}_2, \hat{a}_3^\dagger] &= [t'\hat{a}_0 + r\hat{a}_1, r'^*\hat{a}_0^\dagger + t^*\hat{a}_1^\dagger] = \\ &= t'r'^* [\hat{a}_0, \hat{a}_0^\dagger] + rt^* [\hat{a}_1, \hat{a}_1^\dagger] = t'r'^* + rt^* \stackrel{\text{must be}}{=} 0 \end{aligned}$$



A simple 50/50 beamsplitter (one dielectric layer)

$$\hat{a}_2 = \frac{1}{\sqrt{2}} (\hat{a}_0 + i\hat{a}_1) \quad \hat{a}_3 = \frac{1}{\sqrt{2}} (i\hat{a}_0 + \hat{a}_1)$$

Write as a unitary transformation

$$\begin{pmatrix} \hat{a}_2 \\ \hat{a}_3 \end{pmatrix} = \hat{U} \begin{pmatrix} \hat{a}_0 \\ \hat{a}_1 \end{pmatrix} \hat{U}^\dagger$$

$$\hat{U} = e^{i\pi/4 (\hat{a}_0^\dagger \hat{a}_1 + \hat{a}_0 \hat{a}_1^\dagger)}$$

Heisenberg representation:  
The state of the incident beam is invariant, the mode operators are modified

Schrödinger representation: operators are invariant, but states are changed

Example 1: a single photon on a beam splitter

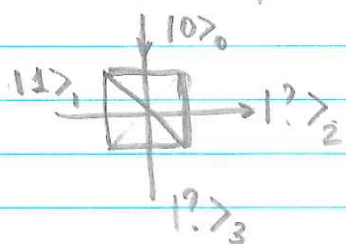

Handy thought:  
vacuum is vacuum  
 $|0\rangle_0 |0\rangle_1 \xrightarrow{\text{BS}} |0\rangle_2 |0\rangle_3$

Initial state  $|\Psi\rangle = \hat{a}_1^\dagger |0\rangle_0 |0\rangle_1$

BS action

$$\frac{1}{\sqrt{2}} (i\hat{a}_2^\dagger + \hat{a}_3^\dagger) |0\rangle_2 |0\rangle_3$$

Final state  $|\Psi'\rangle = \frac{1}{\sqrt{2}} (i|1\rangle_2 |0\rangle_3 + |0\rangle_2 |1\rangle_3)$

A photon goes one way or another with 50% probability

Example 2: coherent state  $|d\rangle$

Initial state:  $|\psi\rangle = |0\rangle_0 |d\rangle_1 = \hat{D}_1(d) |0\rangle_0 |0\rangle_1$

$$\hat{D}_1(d) = e^{d\hat{a}_1^\dagger - d^*\hat{a}_1}$$

BS action

$$= e^{\frac{\alpha}{\sqrt{2}}(i\hat{a}_2^\dagger + \hat{a}_3^\dagger) - \frac{\alpha^*}{\sqrt{2}}(-i\hat{a}_2 + \hat{a}_3)} =$$

$$= e^{\frac{id}{\sqrt{2}}\hat{a}_2^\dagger - \left(\frac{id}{\sqrt{2}}\right)^*\hat{a}_2} \cdot e^{\frac{d}{\sqrt{2}}\hat{a}_3^\dagger - \frac{d}{\sqrt{2}}\hat{a}_3}$$

$$\hat{D}_2\left(\frac{id}{\sqrt{2}}\right) \quad \hat{D}_3\left(\frac{d}{\sqrt{2}}\right)$$

Output:

$$|\psi'\rangle = \hat{D}_2\left(\frac{id}{\sqrt{2}}\right) \hat{D}_3\left(\frac{d}{\sqrt{2}}\right) |0\rangle_2 |0\rangle_3 = \left|\frac{id}{\sqrt{2}}\right\rangle_2 \left|\frac{d}{\sqrt{2}}\right\rangle_3$$

Equally split two coherent states with a relative phase shift

Example 3: Test for single-photon indistinguishability (Hong-Ou-Mandel test)

Initial state  $|1\rangle_0 |1\rangle_1 = \hat{a}_0^\dagger \hat{a}_1^\dagger |0\rangle_0 |0\rangle_1$

$$\hat{a}_0^\dagger \hat{a}_1^\dagger = \frac{1}{2} (\hat{a}_2^\dagger + i\hat{a}_3^\dagger) (i\hat{a}_2^\dagger + \hat{a}_3^\dagger) = \frac{i}{2} [(\hat{a}_2^\dagger)^2 + (\hat{a}_3^\dagger)^2] +$$

$$+ \frac{1}{2} \hat{a}_2^\dagger \hat{a}_3^\dagger - \frac{1}{2} \hat{a}_3^\dagger \hat{a}_2^\dagger = \frac{i}{2} [(\hat{a}_2^\dagger)^2 + (\hat{a}_3^\dagger)^2]$$

Final state  $\frac{i}{2} [(\hat{a}_2^\dagger)^2 + (\hat{a}_3^\dagger)^2] |0\rangle_2 |0\rangle_3 =$

$$= \frac{i}{\sqrt{2}} (|2\rangle_2 |0\rangle_3 + |0\rangle_2 |2\rangle_3)$$

### Photon bunching

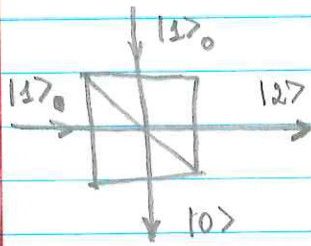

or

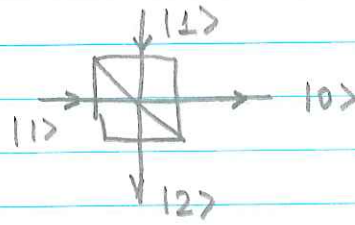

The probability to detect photons at both output simultaneously is zero. (if, of course, the initial photons are indistinguishable)

## Measurement of Subpicosecond Time Intervals between Two Photons by Interference

C. K. Hong, Z. Y. Ou, and L. Mandel

*Department of Physics and Astronomy, University of Rochester, Rochester, New York 14627*

(Received 10 July 1987)

A fourth-order interference technique has been used to measure the time intervals between two photons, and by implication the length of the photon wave packet, produced in the process of parametric down-conversion. The width of the time-interval distribution, which is largely determined by an interference filter, is found to be about 100 fs, with an accuracy that could, in principle, be less than 1 fs.

PACS numbers: 42.50.Bs, 42.65.Re

The usual way to determine the duration of a short pulse of light is to superpose two similar pulses and to measure the overlap with a device having a nonlinear response.<sup>1</sup> The latter might, for example, make use of the process of harmonic generation in a nonlinear medium. Indeed, such a technique was recently used<sup>2</sup> to determine the coherence length of the light generated in the process of parametric down-conversion.<sup>3</sup> The coherence time was found to be of subpicosecond duration, as predicted theoretically.<sup>4</sup> It is, however, in the nature of the technique that it requires very intense light pulses and would be of no use for the measurement of single photons. On the other hand, if we are dealing with two photons and wish to determine the time interval between them, which has a dispersion governed by the length of the photon wave packet, we are usually limited by the resolving time of the photodetector to intervals of order 100 ps or longer.<sup>5</sup>

We wish to report an experiment in which the time interval between signal and idler photons, and by implication the length of a subpicosecond photon wave packet, produced in parametric down-conversion was measured. The technique is based on the interference of two two-photon probability amplitudes in two-photon detection, and is easily able to measure a time interval of 50 fs, with an accuracy that could be 1 fs or better.

An outline of the experiment is shown in Fig. 1. A coherent beam of light of frequency  $\omega_0$  from an argon-ion laser oscillating on the 351.1-nm line falls on an 8-cm-long nonlinear crystal of potassium dihydrogen phosphate, where some of the incident photons split into two lower-frequency signal and idler photons of frequencies  $\omega_1$  and  $\omega_2$ , such that

$$\omega_0 = \omega_1 + \omega_2. \quad (1)$$

The two signal and idler photons are directed by mirrors M1 and M2 to pass through a beam splitter BS as shown, and the superposed beams interfere and are detected by photodetectors D1 and D2. We measure the rate at which photons are detected in coincidence, when the beam splitter is displaced from its symmetry position by various small distances  $\pm c \delta \tau$ . It should be em-

phasized that the signal and idler photons have no definite phase, and are therefore mutually incoherent, in the sense that they exhibit no second-order interference when brought together at detector D1 or D2. However, fourth-order interference effects occur, as demonstrated by the coincidence counting rate between D1 and D2.<sup>6-8</sup> The experiment has some similarities to another, recently reported, two-photon interference experiment in which fringes were observed and measured, but without the use of a beam splitter.<sup>6</sup>

Although the sum frequency  $\omega_1 + \omega_2$  is very well defined in the experiment, the individual down-shifted frequencies  $\omega_1, \omega_2$  have large uncertainties, that, in practice, are largely determined by the pass bands of the interference filters IF inserted in the down-shifted beams, as shown in Fig. 1. These pass bands are of order  $5 \times 10^{12}$  Hz, corresponding to a coherence time for each photon of order 100 fs. Needless to say, the two-photon probability amplitudes at the detectors D1, D2 are expected to interfere only if they overlap to this accuracy or better. We start by examining how this interference arises.

Let us label the field modes on the input sides of the beam splitter by 01, 02 and on the output sides by 1, 2 and suppose first that the light is monochromatic. If we take the state at the input resulting from one degenerate down-conversion to be the two-photon Fock state  $|1_{01}, 1_{02}\rangle$ , then one can show from general arguments<sup>7</sup> that the state on the output side of the beam splitter is

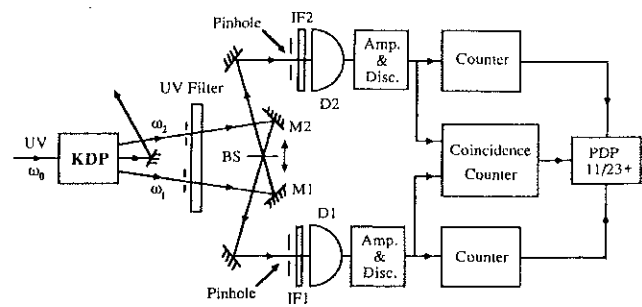

FIG. 1. Outline of the experimental setup.

given by

$$|\psi_{\text{out}}\rangle = (R-T)|1_1, 1_2\rangle + i(2RT)^{1/2}|2_1, 0_2\rangle + i(2RT)^{1/2}|0_1, 2_2\rangle, \quad (2)$$

where  $R$  and  $T$  are the reflectivity and transmissivity of the beam splitter, with  $R+T=1$ . It follows that for a 50%:50% beam splitter with  $R=\frac{1}{2}=T$ , the first term is zero by virtue of the destructive interference of the corresponding two-photon probability amplitudes. No coincidences (other than accidentals) should therefore be registered by detectors D1 and D2.

In practice the down-shifted photons are never monochromatic. Let us represent the two-photon state produced by the potassium-dihydrogen-phosphate crystal by the linear superposition

$$|\psi\rangle = \int d\omega \phi(\omega_1, \omega_0 - \omega_1) | \omega_1, \omega_0 - \omega_1 \rangle, \quad (3)$$

where  $\phi(\omega_1, \omega_2)$  is some weight function which is peaked at  $\omega_1 = \frac{1}{2}\omega_0 = \omega_2$ . (A plausible example is given in Ref. 8.) We assume here that the directions of signal and idler photons are reasonably well defined by apertures, but the frequency spreads are substantial; in practice they are largely determined by the interference filters IF. Then the joint probability of the detection of photons at both detectors D1 and D2 at times  $t$  and  $t+\tau$ , respectively, is given by<sup>9</sup>

$$P_{12}(\tau) = K \langle \hat{E}_1^{(-)}(t) \hat{E}_2^{(-)}(t+\tau) \hat{E}_2^{(+)}(t+\tau) \hat{E}_1^{(+)}(t) \rangle, \quad (4)$$

where  $\hat{E}_1^{(+)}(t)$  and  $\hat{E}_2^{(+)}(t)$  are the positive-frequency parts of the fields at detectors D1 and D2, and  $K$  is a constant characteristic of the detectors.  $\hat{E}_1^{(+)}(t)$  and  $\hat{E}_2^{(+)}(t)$  are related to the fields  $\hat{E}_{01}^{(+)}(t)$  and  $\hat{E}_{02}^{(+)}(t)$  at the two mirrors M1 and M2 shown in Fig. 1. If  $R+T=1$ , then

$$\hat{E}_1^{(+)}(t) = \sqrt{T} \hat{E}_{01}^{(+)}(t - \tau_1) + i\sqrt{R} \hat{E}_{02}^{(+)}(t - \tau_1 + \delta\tau), \quad (5)$$

$$\hat{E}_2^{(+)}(t) = \sqrt{T} \hat{E}_{02}^{(+)}(t - \tau_1) + i\sqrt{R} \hat{E}_{01}^{(+)}(t - \tau_1 - \delta\tau). \quad (6)$$

Here  $\tau_1$  is the propagation time from mirror to detector, and  $\pm c\delta\tau$  represents the small displacement of the beam splitter BS towards one or the other detector.

By combining Eqs. (3) to (6) we may readily show that the joint probability is

$$P_{12}(\tau) = K |G(0)|^2 \{ T^2 |g(\tau)|^2 + R^2 |g(2\delta\tau - \tau)|^2 - RT [g^*(\tau)g(2\delta\tau - \tau) + \text{c.c.}] \}, \quad (7)$$

where  $G(\tau)$  is the Fourier transform of the weight function  $\phi(\omega_0/2 + \omega, \omega_0/2 - \omega)$  with respect to  $\omega$ ,

$$G(\tau) = \int \phi(\omega_0/2 + \omega, \omega_0/2 - \omega) e^{-i\omega\tau} d\omega, \quad (8)$$

and  $g(\tau) \equiv G(\tau)/G(0)$ . This shows how  $P_{12}(\tau)$  varies with the time interval  $\tau$ . If  $\phi(\omega_0/2 + \omega, \omega_0/2 - \omega)$  is real and symmetric in  $\omega$ , as we assume, then  $G(\tau)$  and  $g(\tau)$  are both real and symmetric in  $\tau$ .

In practice the coincidence measurement corresponds to an integration of the probability  $P_{12}(\tau)$  with respect to  $\tau$  over the coincidence resolving time of a few nanoseconds, but as this time is so much longer than the correlation time of  $g(\tau)$  in the experiment, we may effectively integrate  $P_{12}(\tau)$  over all  $\tau$ . From Eq. (7) the expected number  $N_c$  of observed photon coincidences is then given by

$$N_c = C \left[ R^2 + T^2 - 2RT \frac{\int_{-\infty}^{\infty} g(\tau)g(\tau - 2\delta\tau) d\tau}{\int_{-\infty}^{\infty} g^2(\tau) d\tau} \right], \quad (9)$$

where  $C$  is another constant. It follows from this relation that  $N_c = C(R-T)^2$  when  $\delta\tau=0$ , which vanishes when  $R=\frac{1}{2}=T$ , whereas  $N_c = C(T^2+R^2)$  when  $\delta\tau$  appreciably exceeds the correlation time of  $g(\tau)$ . A plot of the number of coincidences  $N_c$  versus the displacement

$\delta\tau$  therefore should exhibit a sharp dip near  $\delta\tau=0$ , of width determined by the length of the wave packet, or coherence time, of the down-shifted photons. The vanishing of the photon coincidence rate is a purely quantum-mechanical feature of the fourth-order interference, as has been shown.<sup>6,8</sup>

In the special case when  $g(\omega_0/2 + \omega, \omega_0/2 - \omega)$  is Gaussian in  $\omega$  with bandwidth  $\Delta\omega$ , then  $g(\tau)$  has the Gaussian form

$$g(\tau) = e^{-(\Delta\omega\tau)^2/2}, \quad (10)$$

and Eq. (9) yields

$$N_c = C(T^2 + R^2) \left[ 1 - \frac{2RT}{R^2 + T^2} e^{-(\Delta\omega\delta\tau)^2} \right]. \quad (11)$$

In the experiment the path difference  $c\delta\tau$  was varied by our mounting the beam splitter on a translator and making very small displacements with a precisely calibrated micrometer. Still finer adjustments can be made with a piezoelectric transducer. The coincidence counting rate was measured by our feeding the amplified and standardized photomultiplier pulses to the start and the stop inputs of a time-to-digital converter, and recording the time interval distribution. Because of the transit-

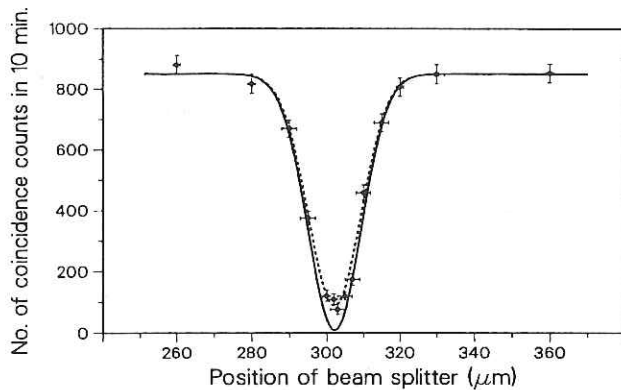

FIG. 2. The measured number of coincidences as a function of beam-splitter displacement  $c\delta\tau$ , superimposed on the solid theoretical curve derived from Eq. (11) with  $R/T=0.95$ ,  $\Delta\omega=3\times 10^{13}$  rad  $s^{-1}$ . For the dashed curve the factor  $2RT/(R^2+T^2)$  in Eq. (11) was multiplied by 0.9. The vertical error bars correspond to one standard deviation, whereas horizontal error bars are based on estimates of the measurement accuracy.

time spread of the photoelectric pulses and the slewing of the discriminator pulses, a range of time intervals centered on zero delay was obtained with a spread of several nanoseconds. For the purpose of the measurement, pulse pairs received within a 7.5-ns interval were treated as "coincident." Pulse pairs received within an interval of 35 to 80 ns were regarded as accidentals, and when scaled by the factor 7.5/45 provided a measure of the number of accidental coincidences that occur within any 7.5-ns interval.

The results of the experiment are presented in Fig. 2, which is a plot of the number of observed photon coincidences, after subtraction of accidentals, as a function of the displacement of the beam splitter. It will be seen that for a certain symmetric position of the beam splitter, the two-photon coincidence rate falls to a few percent of its value in the wings, by virtue of the destructive interference of the two two-photon probability amplitudes. The width of the dip in the coincidence rate provides a measure of the length of the photon wave packet. It is found to be about 16  $\mu\text{m}$  at half height, corresponding to a time of about 50 fs, which should really be doubled to allow for the greater movement of the mirror image. This time is about what is expected from the passband of the interference filters.

Direct measurements of the beam-splitter reflectivity

and transmissivity show that  $R/T \approx 0.95$ , which makes the combination  $2RT/(R^2+T^2) \approx 0.999$ , and implies that  $N_c$  should fall close to zero when  $\delta\tau=0$ . That it does not fall quite that far is probably due to a slight lack of overlap of the signal and idler fields admitted by the two pinholes, causing less than perfect destructive interference. The solid curve in Fig. 2 is based on Eq. (11) with  $R/T=0.95$  and  $\Delta\omega=3\times 10^{13}$  rad/s  $\approx 5\times 10^{12}$  Hz, if we identify  $c\delta\tau$  with the beam-splitter displacement ( $x-302.5$ ) in micrometers. For the dashed curve the factor  $2RT/(R^2+T^2)$  was multiplied by 0.9 to allow for less than perfect overlap of the signal and idler photons. It will be seen that, except for the minimum, Eq. (11) is obeyed quite well, corresponding to a coherence time of about 100 fs.

We have therefore succeeded in measuring subpicosecond time intervals between two photons, and by implication the length of the photon wave packet, by a fourth-order interference technique. Unlike second-order interference, this method does not require that path differences be kept constant to within a fraction of a wavelength. The method is applicable to other situations in which pairs of single photons are produced, but becomes less efficient for more intense pulses of light, because the "visibility" of the interference is then reduced and cannot exceed 50% at high intensities.<sup>6</sup> In principle, the resolution could be better than 1  $\mu\text{m}$  in length or 1 fs in time.

This work was supported by the National Science Foundation and by the U.S. Office of Naval Research.

<sup>1</sup>See, for example, E. P. Ippen and C. V. Shank, in *Ultrashort Light Pulses*, edited by S. L. Shapiro (Springer-Verlag, Berlin, 1984), 2nd ed., p. 83.

<sup>2</sup>I. Abram, R. K. Raj, J. L. Oudar, and G. Dolique, *Phys. Rev. Lett.* **57**, 2516 (1986).

<sup>3</sup>D. C. Burnham and D. L. Weinberg, *Phys. Rev. Lett.* **25**, 84 (1970).

<sup>4</sup>C. K. Hong and L. Mandel, *Phys. Rev. A* **31**, 2409 (1985).

<sup>5</sup>S. Friberg, C. K. Hong, and L. Mandel, *Phys. Rev. Lett.* **54**, 2011 (1985).

<sup>6</sup>R. Ghosh and L. Mandel, *Phys. Rev. Lett.* **59**, 1903 (1987).

<sup>7</sup>Z. Y. Ou, C. K. Hong, and L. Mandel, to be published.

<sup>8</sup>R. Ghosh, C. K. Hong, Z. Y. Ou, and L. Mandel, *Phys. Rev. A* **34**, 3962 (1986).

<sup>9</sup>R. J. Glauber, *Phys. Rev.* **130**, 2529 (1983), and **131**, 2766 (1963).