

Teachspin

Instructional Pulsed NMR Apparatus

Instruction Manual

**Department of Physics and Astronomy
401 Nielsen Physics Building
The University of Tennessee
Knoxville, TN 37996-1200**

Introduction

In 1946 nuclear magnetic resonance (NMR) in condensed matter was discovered simultaneously by Edward Purcell at Harvard and Felix Bloch at Stanford using different instrumentation and techniques. Both groups, however, observed the response of magnetic nuclei, placed in a uniform magnetic field, to a continuous (cw) radio frequency magnetic field as the field was tuned through resonance. This discovery opened up a new form of spectroscopy which has become one of the most important tools for physicists, chemists, geologists, and biologists.

In 1950 Erwin Hahn, a young postdoctoral fellow at the University of Illinois, explored the response of magnetic nuclei in condensed matter to pulse bursts of these same radio frequency (rf) magnetic fields. Hahn was interested in observing transient effects on the magnetic nuclei after the rf bursts. During these experiments he observed a spin echo signal; that is, a signal from the magnetic nuclei that occurred after a two pulse sequence at a time equal to the delay time between the two pulses. This discovery, and his brilliant analysis of the experiments, gave birth to a new technique for studying magnetic resonance. This pulse method originally had only a few practitioners, but now it is the method of choice for most laboratories. For the first twenty years after its discovery, continuous wave (cw) magnetic resonance apparatus was used in almost every research chemistry laboratory, and no commercial pulsed NMR instruments were available. However, since 1966 when Ernst and Anderson showed that high resolution NMR spectroscopy can be achieved using Fourier transforms of the transient response, and cheap fast computers made this calculation practical, pulsed NMR has become the dominant commercial instrumentation for most research applications.

This technology has also found its way into medicine. MRI (magnetic resonance imaging; the word "nuclear" being removed to relieve the fears of the scientifically illiterate public) scans are revolutionizing radiology. This imaging technique seems to be completely noninvasive, produces remarkable three dimensional images, and has the potential to give physicians detailed information about the inner working of living systems. For example, preliminary work has already shown that blood flow patterns in both the brain and the heart can be studied without dangerous catheterization or the injection of radioactive isotopes. Someday, MRI scans may be able to pinpoint malignant tissue without biopsies. MRI is in its infancy, and we will see many more applications of this diagnostic tool in the coming years.

You have purchased the first pulsed NMR spectrometer designed specifically for teaching. The PS1-A is a complete spectrometer, including the magnet, the pulse generator, the oscillator, pulse amplifier, sensitive receiver, linear detector, and sample probe. You need only supply the oscilloscope and the substances you wish to study. Now you are ready to learn the fundamentals of pulsed nuclear magnetic resonance spectroscopy.

Nuclear magnetic resonance is a vast subject. Tens of thousands of research papers and hundreds of books have been published on NMR. We will not attempt to explain or even to summarize this literature. Some of you may only wish to do a few simple experiments with the apparatus and achieve a basic conceptual understanding, while others may aim to understand the details of the density matrix formulation of relaxation processes and do some original research. The likelihood is that the majority of students will work somewhere in between these two extremes. In this section we will provide a brief theoretical introduction to many important ideas of PNMR. This will help you get started and can be referred to later. These remarks will be brief, not completely worked out from first principles, and not intended as a substitute for a careful study of the literature and published texts. An extensive annotated bibliography of important papers and books on the subject is provided at the end of this section.

Magnetic resonance is observed in systems where the magnetic constituents have **both a magnetic moment and an angular momentum**. Many, but not all, of the stable nuclei of ordinary matter have this property. In "classical physics" terms, magnetic nuclei act like a small spinning bar magnet. For this instrument, we will only be concerned with one nucleus, the nucleus of hydrogen, which is a single proton. The proton can be thought of as a small spinning bar magnet with a magnetic moment μ and an angular momentum J , which are related by the vector equation:

$$\mu = \gamma J \quad (1.1)$$

where γ is called the "gyromagnetic ratio." The nuclear angular momentum is quantized in units of h as:

$$J = \hbar I \quad (2.1)$$

where I is the "spin" of the nucleus.

The magnetic energy U of the nucleus in an external magnetic field is

$$U = -\mu \cdot B \quad (3.1)$$

If the magnetic field is in the z-direction, then the magnetic energy is

$$U = -\mu_z B_0 = -\gamma \hbar I_z B_0 \quad (4.1)$$

Quantum mechanics requires that the allowed values of I_z , m_l be quantized as

$$m_l = I, I-1, I-2, I-3, \dots, -I. \quad (5.1)$$

For the proton, with spin one half ($I = 1/2$), the allowed values of I_z are simply

$$m_l = \pm 1/2 \quad (6.1)$$

which means there are only two magnetic energy states for a proton residing in a constant magnetic field B_0 . These are shown in figure 1.1. The energy separation between the two states ΔU can be written in terms of an angular frequency or as

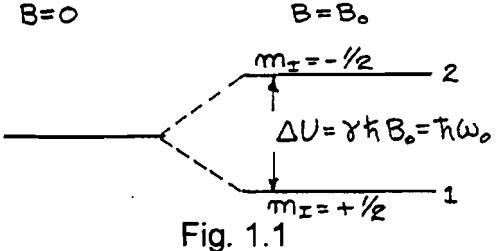
$$\Delta U = \hbar\omega_0 = \gamma\hbar B_0 \quad \text{or} \quad \boxed{\omega_0 = \gamma B_0} \quad (7.1)$$

This is the fundamental resonance condition. . For the proton

$$\gamma_{\text{proton}} = 2.675 \times 10^4; \text{rad/sec-gauss}^* \quad (8.1)$$

so that the resonant frequency is related to the constant magnetic field for the proton by

$$\boxed{f_0 \text{ (MHz)} = 4.258 B_0 \text{ (kilogauss)}} \quad (9.1)$$

a number worth remembering.

If a one milliliter (ml) sample of water (containing about 7×10^{19} protons) is placed in a magnetic field in the z-direction, a nuclear magnetization in the z-direction eventually becomes established. This nuclear magnetization occurs because of unequal population of the two possible quantum states. If N_1 and N_2 are the number of spins per unit volume in the respective states, then the population ratio (N_2 / N_1), in thermal equilibrium, is given by the Boltzmann factor as

$$\left[\frac{N_2}{N_1} \right] = e^{-\frac{\Delta U}{kT}} = e^{-\frac{h\omega_0}{kT}} \quad (10.1)$$

and the magnetization is

$$M_z = (N_1 - N_2) \mu \quad (11.1)$$

The thermal equilibrium magnetization per unit volume for N magnetic moments is

*Gauss has been the traditional unit to measure magnetic fields in NMR but the tesla is the proper SI unit, where 1 tesla = 10^4 gauss.

$$M_0 = N\mu \tanh\left(\frac{\mu B}{kT}\right) \approx N\frac{\mu^2 B}{kT} \quad (12.1)$$

$$\text{where } N = N_1 + N_2$$

This magnetization does *not* appear instantaneously when the sample is placed in the magnetic field. It takes a finite time for the magnetization to build up to its equilibrium value along the direction of the magnetic field (which we define as the z-axis). For most systems, the z-component of the magnetization is observed to grow exponentially as depicted in Figure 2.1.

The differential equation that describes such a process assumes the rate of approach to equilibrium is proportional to the separation from equilibrium :

$$\frac{dM_z}{dt} = \frac{M_0 - M_z}{T_1} \quad (13.1)$$

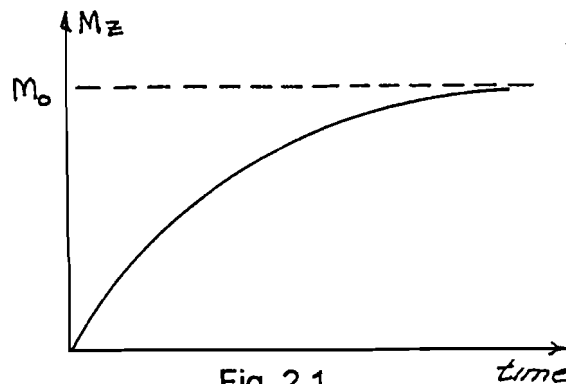

Fig. 2.1

where T_1 is called the spin-lattice relaxation time. If the unmagnetized sample is placed in a magnetic field, so that at $t = 0$, $M_z = 0$, then direct integration of equation 13.1, with these initial conditions, gives

$$M_z(t) = M_0\left(1 - e^{-\frac{t}{T_1}}\right) \quad (14.1)$$

The rate at which the magnetization approaches its thermal equilibrium value is characteristic of the particular sample. Typical values range from microseconds to seconds. What makes one material take $10 \mu\text{s}$ to reach equilibrium while another material (also with protons as the nuclear magnets) takes 3 seconds? Obviously, some processes in the material make the protons "relax" towards equilibrium at different rates. The study of these processes is one of the major topics in magnetic resonance.

Although we will not attempt to discuss these processes in detail, a few ideas are worth noting. In thermal equilibrium more protons are in the lower energy state than the upper. When the unmagnetized sample was first put in the magnet, the protons occupied the two states equally that is ($N_1 = N_2$). During the magnetization process energy must flow *from* the nuclei *to* the surroundings, since the magnetic energy from the spins is reduced. The surroundings which absorb this energy is referred to as "the lattice", even for liquids or gases. Thus, the name "spin-lattice" relaxation time for the characteristic time of this energy flow.

However, there is more than energy flow that occurs in this process of magnetization. Each proton has angular momentum (as well as a magnetic moment) and the angular momentum must also be transferred from the spins to the lattice during magnetization. In quantum mechanical terms, the lattice must have angular momentum states available when a spin goes from $m_l = -1/2$ to $m_l = +1/2$. In classical physics terms, the spins must experience a **torque** capable of changing their angular momentum. The existence of such states is usually the critical determining factor in explaining the enormous differences in T_1 for various materials. Pulsed NMR is ideally suited for making precise measurements of this important relaxation time. The pulse technique gives a direct unambiguous measurement, whereas cw spectrometers use a difficult, indirect, and imprecise technique to measure the same quantity.

What about magnetization in the x-y plane? In thermal equilibrium the only net magnetization of the sample is M_z , the magnetization along the external constant magnetic field. This can be understood from a simple classical model of the system. Think of placing a collection of tiny current loops in a magnetic field. The torque τ on the loop is $\mu \times B$ and that torque causes the angular momentum of the loop to change, as given by:

$$\tau = \frac{dJ}{dt} \quad \text{or} \quad \mu \times B = \frac{dJ}{dt} \quad (15.1)$$

which for our protons becomes

$$\mu \times B = \frac{1}{\gamma} \frac{d\mu}{dt} \quad (16.1)$$

Equation 16.1 is the classical equation describing the time variation of the magnetic moment of the proton in a magnetic field. It can be shown from equation 16.1 that the magnetic moment will execute precessional motion, depicted in Figure 3.1. The precessional frequency $\omega_0 = \gamma B_0$ is just the resonant frequency in equation 7.1.

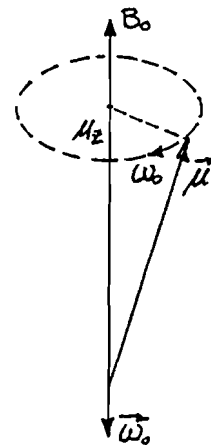

Fig.3.1

If we add up all the magnetization for the 10^{20} protons in our sample in thermal equilibrium, the μ_z components sum to M_z , but the x and y components of the individual magnetic moments add to zero. For the x-components of every proton to add up to some M_x , there must be a definite phase relationship among all the precessing spins. For example, we might start the precessional motion with the x-component of the spins lined up along the x-axis. But that is not the case for a

sample simply placed in a magnet. In thermal equilibrium the spin components in the x-y plane are randomly positioned. Thus, in thermal equilibrium there is no transverse (x and y) component of the net magnetization of the sample. However, as we shall soon see, there is a way to **create** such a transverse magnetization using radio frequency pulsed magnetic fields. The idea is to rotate the thermal equilibrium magnetization M_z into the x-y plane and thus create a temporary M_x and M_y . Let's see how this is done.

Equation 16.1 can be generalized to describe the classical motion of the net magnetization of the entire sample. It is

$$\frac{d\mathbf{M}}{dt} = \gamma \mathbf{M} \times \mathbf{B} \quad (17.1)$$

where \mathbf{B} is any magnetic field, including time dependent rotating fields. Suppose we apply not only a constant magnetic field $B_0 \hat{k}$, but a rotating (circularly polarized) magnetic field of frequency ω in the X-Y plane so the **total** field is written as *

$$\mathbf{B}(t) = B_1 \cos \omega t \hat{i} + B_1 \sin \omega t \hat{j} + B_0 \hat{k} \quad (18.1)$$

The analysis of the magnetization in this complicated time dependent magnetic field can best be carried out in a noninertial rotating coordinate system. The coordinate system of choice is rotating at the same angular frequency as the rotating magnetic field with its axis in the direction of the static magnetic field. In this rotating coordinate system the rotating magnetic field appears to be stationary and aligned along the x^* -axis (Fig. 4.1). However, from the point of view of the rotating coordinate system, B_0 and B_1 are not the only magnetic field. An **effective field** along the z^* - direction, of magnitude $-\frac{\omega}{\gamma} \hat{k}^*$ must also be included. Let's justify this new effective magnetic field with the following physical argument.

Equations 16.1 and 17.1 predict the precessional motion of a magnetization in a constant magnetic field $B_0 \hat{k}$. Suppose one observes this precessional motion from a rotating coordinate system which rotates at the precessional frequency. In this frame of reference the magnetization appears stationary, in some fixed position. The only way a magnetization can remain fixed in space is if there is no torque on it. If the magnetic field is zero in the reference frame, then the torque on \mathbf{M} is always zero no matter what direction \mathbf{M} is oriented. The magnetic field is zero (in the rotating frame) if we add the effective field $-\frac{\omega}{\gamma} \hat{k}^*$ which is equal to $B_0 \hat{k}^*$.

* What is actually applied is an oscillating field $2B_1 \cos \omega t \hat{i}$ but that can be decomposed into two counter rotating fields $B_1(\cos \omega t \hat{i} + \sin \omega t \hat{j}) + B_1(\cos \omega t \hat{i} - \sin \omega t \hat{j})$. The counter rotating field can be shown to have no practical effects on the spin system and can be ignored in this analysis.

Transforming the magnetic field expression in equation (18.1) into such a rotating coordinate system, the total magnet field in the rotating frame \mathbf{B}^* is

$$\mathbf{B}_{eff}^* = B_1 \hat{j}^* + (B_0 - \frac{\omega}{\gamma}) \hat{k}^* \quad (19.1)$$

shown in Figure 4.1. The classical equation of motion of the magnetization as observed in the rotating frame is then

$$\frac{d\mathbf{M}}{dt} = \gamma \mathbf{M} \times \mathbf{B}_{eff}^* \quad (20.1)$$

which shows that \mathbf{M} will precess about \mathbf{B}_{eff}^* in the rotating frame.

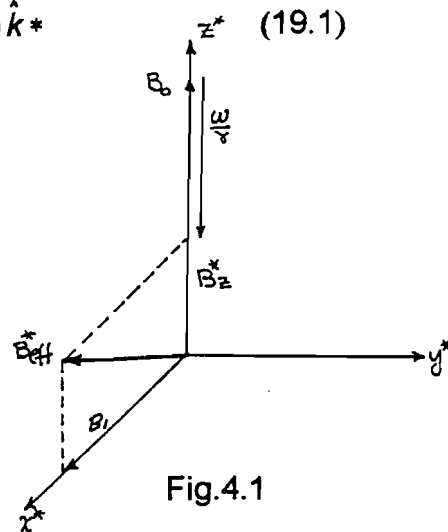

Fig.4.1

Suppose now, we create a rotating magnetic field at a frequency ω_0 as such that

$$\frac{\omega}{\gamma} = B_0 \quad \text{or} \quad \omega = \gamma B_0 = \omega_0 \quad (21.1)$$

In that case, $\mathbf{B}_{eff}^* = B_1 \hat{j}^*$, a constant magnetic field in the x^* -direction. Then the magnetization M_z begins to precess about this magnetic field at a rate $\Omega = \gamma B_1$ (in the rotating frame). If we **turn off** the B_1 field at the instant the magnetization reaches the x - y plane, we will have created a transient (non-thermal equilibrium) situation where there **is** a net magnetization in the x - y plane. If this rotating field is applied for twice the time the transient magnetization will be $-M_z$ and if it is left on four times as long the magnetization will be back where it started, with M_z along the z^* -axis. These are called:

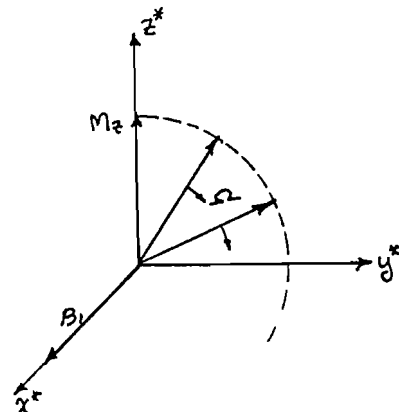

Fig.5.1

$$\begin{aligned} 90^\circ \text{ or } \pi/2 \text{ pulse} &\rightarrow M_z \rightarrow M_y \\ 180^\circ \text{ or } \pi \text{ pulse} &\rightarrow M_z \rightarrow -M_z \\ 360^\circ \text{ or } 2\pi \text{ pulse} &\rightarrow M_z \rightarrow M_z \end{aligned}$$

In the laboratory (or rest) frame where the experiment is actually carried out, the magnetization not only precesses about B_1 but rotates about \hat{k} during the pulse. It is not possible, however, to observe the magnetization **during** the pulse. Pulsed NMR signals are observed **AFTER THE TRANSMITTER PULSE IS OVER**. But,

what is there to observe AFTER the transmitter pulse is over? The spectrometer detects the net magnetization precessing about the constant magnetic field $B_0 \hat{k}$ in the x-y plane. **Nothing Else!**

Suppose a 90° ($\pi/2$) pulse is imposed on a sample in thermal equilibrium. The net equilibrium magnetization will be rotated into the x-y plane where it will precesses about $B_0 \hat{k}$. But the x-y magnetization will not last forever. For most systems, this magnetization decays exponentially as shown in Figure 6.1. The differential equations which describe the decay in the rotating coordinate system are:

$$\frac{dM_{x'}}{dt} = -\frac{M_{x'}}{T_2} \quad \text{and} \quad \frac{dM_{y'}}{dt} = -\frac{M_{y'}}{T_2} \quad (22.1)$$

whose solutions are

$$M_{x'}(t) = M_0 e^{-\frac{t}{T_2}} \quad \text{and} \quad M_{y'} = M_0 e^{-\frac{t}{T_2}} \quad (23.1)$$

where the characteristic decay time T_2 is called the Spin-Spin Relaxation Time. One simple way to understand this relaxation process from the classical perspective, is to recall that each proton is itself a magnet and produces a magnetic field at its neighbors. Therefore for a given distribution of these protons there must also be a distribution of

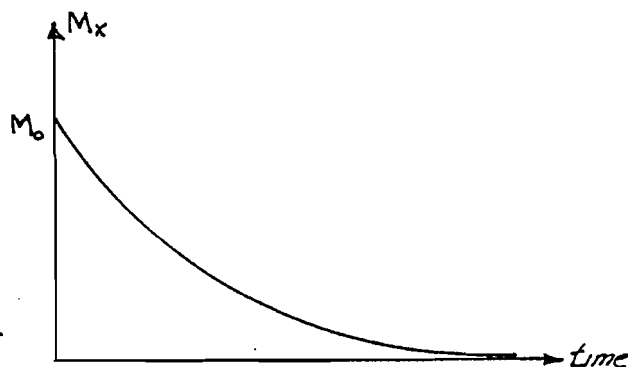

Fig. 6.1

local fields at the various proton sites. Thus, the protons precess about $B_0 \hat{k}$ with a distribution of frequencies, not a single frequency ω_0 . Even if all the protons begin in phase (after the 90° pulse) they will soon get out of phase and the net x-y magnetization will eventually go to zero. A measurement of T_2 , the decay constant of the x-y magnetization, gives information about the distribution of local fields at the nuclear sites.

From this analysis it would appear that the spin-spin relaxation time T_2 can simply be determined by plotting the decay of M_x (or M_y) after a 90° pulse. This signal is called the **free precession or free induction decay (FID)**. If the magnet's field were perfectly uniform over the entire sample volume, then the time constant associated with the free induction decay would be T_2 . But in most cases it is the magnet's nonuniformity that is responsible for the observed decay constant of the FID. The PSI-A's magnet, at its "sweet spot," has sufficient uniformity to produce at least a .3 millisecond delay time. Thus, for a sample whose $T_2 < .3\text{ms}$ the free

induction decay constant is also the T_2 of the sample. But what if T_2 is actually .4msec or longer? The observed decay will still be about .3ms. Here is where the genius of Erwin Hahn's discovery of the spin echo plays its crucial role.

Before the invention of pulsed NMR, the only way to measure the real T_2 was to improve the magnets homogeneity and make the sample smaller. But, PNMR changed this. Suppose we use a two pulse sequence, the first one 90° and the second one, turned on a time τ later, a 180° pulse. What happens? Figure 7.1 shows pulse sequence and Figure 8.1 shows the progression of the magnetization in the rotating frame.

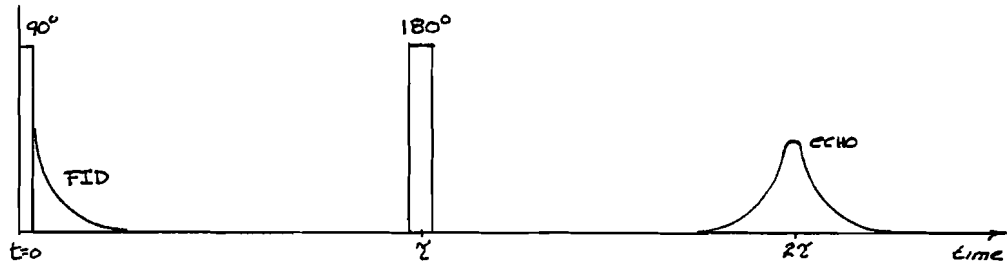

Fig 7.1

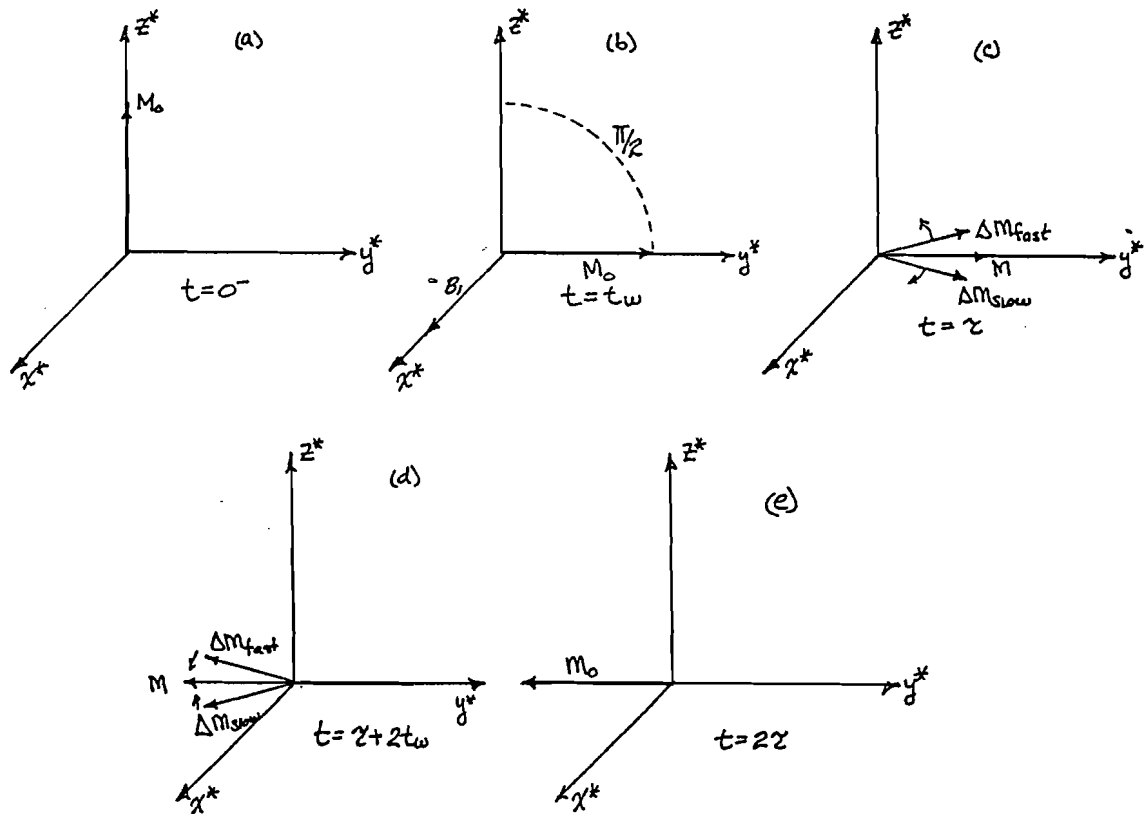

Fig. 8.1 : a) Thermal equilibrium magnetization along the z axis before the rf pulse. b) M_0 rotated to the y-axis after the 90° pulse. c) The magnetization in the x-y plane is decreasing because some spins Δm_{fast} are in a higher field, and some Δm_{slow} in a lower field static field. d) spins are rotated 180° (flip the entire x-y plane like a pancake on the griddle) by the pulsed rf magnetic field. e) The rephasing the three magnetization "bundles" to form an echo at $t = 2\tau$.

Study these diagrams carefully. The 180° pulse allows the x-y magnetization to rephase to the value it would have had with a perfect magnet. This is analogous to an egalitarian foot race for the kindergarten class; the race that makes everyone in the class a winner. Suppose you made the following rules. Each kid would run in a straight line as fast as he or she could and when the teacher blows the whistle, every child would turn around and run back to the finish line, again as fast as he or she can run. The faster runners go farther, but must return a greater distance and the slower ones go less distance, but all reach the finish line at the same time. The 180° pulse is like that whistle. The spins in the larger field get out of phase by $+\Delta\theta$ in a time τ . After the 180° pulse, they continue to precess faster than M but at 2τ they return to the in-phase condition. The slower precessing spins do just the opposite, but again rephase after a time 2τ .

Yet some loss of $M_{x,y}$ magnetization has occurred and the maximum height of the echo is not the same as the maximum height of the FID. This loss of transverse magnetization occurs because of stochastic fluctuation in the local fields at the nuclear sites which is not rephasable by the 180° pulse. These are the real T_2 processes that we are interested in measuring. A series of 90° - τ - 180° pulse experiments, varying τ , and plotting the echo height as a function of time between the FID and the echo, will give us the "real" T_2

The transverse magnetization as measured by the maximum echo height is written as:

$$M_{x,y}(2\tau) = M_0 e^{-\frac{2\tau}{T_2}} \quad (24.1)$$

That's enough theory for now. **Let's summarize:**

1. Magnetic resonance is observed in systems whose constituent particles have both a magnetic moment and angular momentum.
2. The resonant frequency of the system depends on the applied magnetic field in accordance with the relationship $\omega_0 = \gamma B_0$ where

$$\gamma_{\text{proton}} = 2.675 \times 10^4 \text{ rad/sec-gauss}$$

or

$$f_0 = 4.258 \text{ MHz/kilogauss}$$

3. The thermal equilibrium magnetization is parallel to the applied magnetic field, and approaches equilibrium following an exponential rise characterized by the constant T_1 , the spin-lattice relaxation time.

4. Classically, the magnetization obeys the differential equation

$$\frac{d\mathbf{M}}{dt} = \gamma(\mathbf{M} \times \mathbf{B})$$

where \mathbf{B} may be a time dependent field.

5. Pulsed NMR employs a rotating radio frequency magnetic field described by

$$\mathbf{B}(t) = B_1 \cos \omega t \hat{i} + B_1 \sin \omega t \hat{j} + B_0 \hat{k}$$

6. The easiest way to analyze the motion of the magnetization during and after the rf pulsed magnetic field is to transform into a rotating coordinate system. If the system is rotating at an angular frequency ω along the direction of the magnetic field, a fictitious magnetic field must be added to the real fields such that the total effective magnetic field in the rotating frame is:

$$\mathbf{B}_{eff}^* = H_1 \hat{i}^* + (B_0 - \frac{\omega}{\gamma}) \hat{k}^*$$

7. On resonance $\omega = \omega_0 = \gamma B_0$ and $\mathbf{B}_{eff}^* = H_1 \hat{i}^*$. In the rotating frame during the pulse the spins precess around B_1^* ,

8. A 90° pulse is one where the pulse is left on just long enough (t_w) for the equilibrium magnetization M_0 to rotate to the x-y plane. That is;

$$\omega_1 t_w = \pi/2 \text{ radians} \quad \text{or} \quad t_w = \frac{\pi}{2\omega_1}$$

But

$$\omega_1 = \gamma B_1 \quad (\text{since the } B_1 \text{ is the only field in the rotating frame on resonance})$$

So,

$$t_w(90^\circ) = \frac{\pi}{2\gamma B_1} \quad \text{duration of the } 90^\circ \text{ pulse} \quad (25.1)$$

9. T_2 - the spin-spin relaxation time is the characteristic decay time for the nuclear magnetization in the x-y (or transverse) plane.

10. The spin-echo experiments allow the measurement of T_2 in the presence of a nonuniform static magnetic field. For those cases where the free induction decay time constant, (sometimes written T_2^*) is shorter than the real T_2 , the decay of the echo envelope's maximum heights for various times τ , gives the real T_2 .

References

Books

C.P. Slichter: "Principles of Magnetic Resonance" Springer Series in Solid-State Sciences 1 Third Edition (1990) Springer-Verlag

A complete text with problems, clear explanations, appropriate for advanced undergraduate or graduate level students. Excellent Bibliography. ***Any serious student of magnetic resonance should own it.*** Everyone should read at least some of it.

T.C. Farrar, E.D. Becker: "Pulsed And Fourier Transform NMR", Academic Press 1971

A good introduction, with simplified mathematics, to the subject. Gives students a physical feel for the basic ideas of PNMR.

G. E. Pake and T. L. Estle: "The Physical Principles of Electron Paramagnetic Resonance", Benjamin-Cummings, Menlo Park CA (1978)

Don't let the title ESR scare you away from using this excellent text. It has clear discussions of important ideas of magnetic resonance, such as the rotating coordinate systems etc.

R. T. Schumacher: "Introduction to Magnetic Resonance", Benjamin-Cummings, Menlo Park CA 1970.

N. Bloembergen: "Nuclear Magnetic Relaxation", W.A. Benjamin, New York 1961

This is Bloembergen's Ph.D. thesis, reprinted, but it is like no other thesis you will ever read. Describes some of the classic ideas of magnetic resonance, still very worth reading, you will see why he is a Nobel Laureate.

A. Abragam: "Principles of Nuclear Magnetism", Clarendon, Oxford 1961

This text is in a class by itself, but not easy for the beginner. Abragam has his own way of describing NMR. Important, but clearly for advanced students.

E. Andrew, "Nuclear Magnetic Resonance" Cambridge University Press, New York, 1955

A good general discussion of theory, experimental methods, and applications of NMR.

C. Kittel "Introduction to Solid State Physics" 5th edition, Wiley, New York 1976 in Chapter 16. A reasonable place to begin the subject of magnetic resonance, very brief, not fully worked out, but a good first overview.

D. M. S. Bagguley editor: "Pulsed Magnetic Resonance: NMR, ESR, and Optics, a Recognition of E. L. Hahn, Clarendon Press, Oxford 1992.
A wonderful collection of historical reminiscences and modern research applications of pulsed magnetic resonance. Useful for advanced students.

Papers

E. L. Hahn: "Spin echoes" Phys. Rev 80, 580-594 (1950)
The first report of PNMR and still a wonderful explanation, worth reading.

H. Y. Carr, E. M. Purcell: Effects of diffusion on free precession in nuclear magnetic resonance experiments. Phys Rev 94, 630-638 (1954)
Anything Ed Purcell signs his name to is worth reading! This certainly is one such example. A must for PNMR.

N. Bloembergen, E. M. Purcell, and R. B. Pound, "Relaxation effects in Nuclear Magnetic Resonance absorption," Phys. Rev. 73, 679-712 (1948)
A classic paper describing basic relaxation processes in NMR.

S. Meiboom, D. Gill: Rev of Sci Instruments 29, 6881 (1958)
The description of the phase shift technique that opened up multiple pulse techniques to measuring very long T_2 's in liquids.

K. Symon, "Mechanics" 3d ed. Addison-Wesley, Reading, MA (1971)
A good place to learn about rotating coordinate systems, if you don't already understand them.

R. G. Beaver, E. L. Hahn, Scientific American 6, 251 (1984)
A discussion of the echo phenomenon and mechanical memory.

Charles Slichter's book, the first reference, contains a nearly complete bibliography of the important papers in NMR and ESR. Consult this text for references to particular subjects.

THE INSTRUMENT

I. Introduction

TeachSpin's PS1-A is the first pulsed nuclear magnetic resonance spectrometer designed specifically for teaching. It provides physics, chemistry, biology, geology, and other science students with the hands-on apparatus with which they can learn the basic principles of pulsed NMR. It was developed by faculty with more than 60 years of accumulated research and teaching in the field of magnetic resonance. Its modular construction allows you to experiment with each part of the apparatus separately to understand its function as well as to make the appropriate interconnections between the modules. For its high field, high homogeneity permanent magnet, the PS1-A uses new high-energy magnetic materials. Solid-state technology is employed in the digitally synthesized oscillator which creates a stable frequency source. Unique switching and power amplifier circuits create coherent and stable pulsed radio frequency magnetic fields. The spectrometer uses a crossed-coil sample probe with a separate transmitter and receiver coil which are orthogonal. This design completely separates the transmitter and receiver functions and makes their analysis easy to understand, measure and test.

PS1-A has a state-of-the-art high sensitivity, high gain receiver with a linear detector that permits accurate measurement of the signal amplitude even at low levels. The instrument is not only easy to use, it is easy to understand since each module has its own clearly defined function in the spectrometer and is accessible to individual examination. The spectrometer is complete, requiring only your samples and an oscilloscope to record the data. The Hewlett Packard 54600A digital storage scope is highly recommended for this purpose, since it is well engineered, easy to operate, reasonably priced, and will greatly simplify data taking and analysis. However, a standard analog scope with a bandwidth of at least 20 MHz will also adequately serve to record the pulsed signals. The spectrometer is capable of measuring a wide variety of samples which have appreciable proton concentrations. The only restriction is that the sample's $T_2 \geq 5 \times 10^{-5}$ s which includes most liquids and some solid condensed matter.

II. Block Diagram of Instrument

Figure 1.2 is a simplified block diagram of the apparatus. The diagram does not show all the functions of each module, but it does represent the most important functions of each modular component of the spectrometer.

The pulse programmer creates the pulse stream that gates the synthesized oscillator into radio frequency pulse bursts, as well as triggering the oscilloscope on the appropriate pulse. The rf pulse bursts are amplified and sent to the transmitter

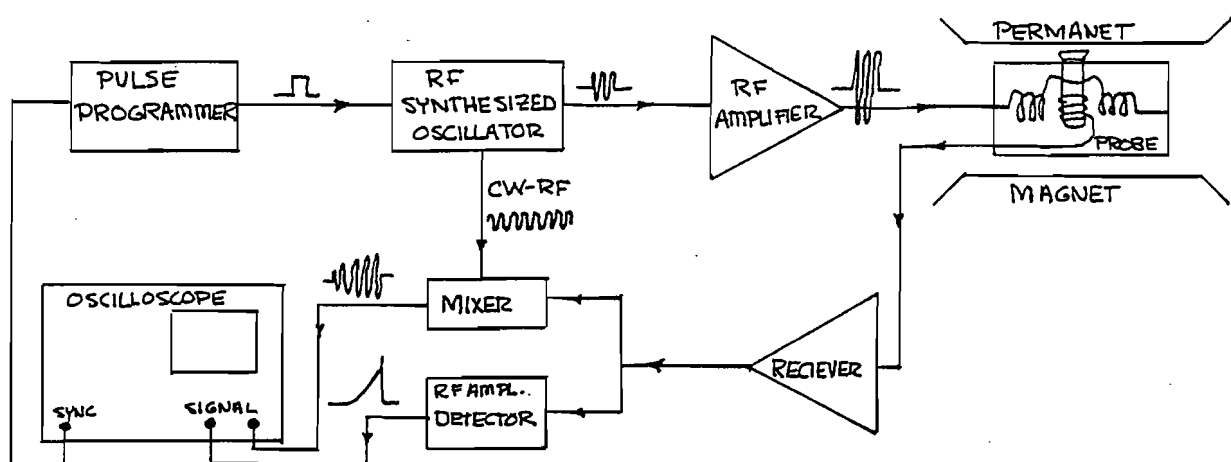

Fig. 1.2

coils in the sample probe. The rf current bursts in these coil produce a homogeneous 12 gauss rotating magnetic field at the sample. These are the time-dependent B_1 fields that produce the precession of the magnetization, referred to as the 90° or 180° pulses. The transmitter coils are wound in a Helmholtz configuration to optimize rf magnetic field homogeneity.

Nuclear magnetization precession in the direction transverse to the applied constant magnetic field (the so called x-y plane) induces an EMF in the receive coil, which is then amplified by the receiver circuitry. This amplified radio frequency (15 MHz) signal can be detected (demodulated) by two separate and different detectors. The rf **amplitude** detector rectified the signal and has an output proportioned to the peak amplitude of the rf precessional signal. **This is the detector that you will use to record both the free induction decays and the spin echoes signals.**

The other detector is a **mixer**, which effectively multiplies the precession signal from the sample magnetization with the master oscillator. Its output frequency is proportional to the difference between the two frequencies. **This mixer is essential for determining the proper frequency of the oscillator.** The magnet and the nuclear magnetic moment of the protons uniquely determine the precessional frequency of the nuclear magnetization. The oscillator is tuned to this precession frequency when a zero-beat output signal of the mixers obtained. A dual channel scope allows simultaneous observations of the signals from both detectors, The field of the permanent magnet is temperature dependent so periodic adjustments in the frequency are necessary to keep the spectrometer on resonance.

III. The Spectrometer

A. Magnet

The magnetic field strength has been measured at the factory. The value of the field at the center of the gap is recorded on the serial tag located on the back side of the yoke. Each magnet comes equipped with a carriage mechanism for manipulating the sample probe in the transverse (x-y) plane. The location of the probe in the horizontal direction is indicated on the scale located on the front of the yoke and the vertical position is determined by the dial indicator on the carriage. The vertical motion mechanism is designed so that one rotation of the dial moves the probe 0.2 centimeters. The probe is at the geometric center of the field when the dial indicator reads 10.0.

Vertical Position	0.2 centimeters / turn
Field Center	- Dial at 10.0 Turns

It is important not to force the sample probe past its limits of travel. This can damage the carriage mechanism. Periodic lubrication may be necessary. A light oil, WD-30, or similar product works best. Once or twice a year should be sufficient. The carriage should work smoothly, **do not force it.**

The clear plastic cover should be kept closed except when changing samples. Small magnetic parts, like paper clips, pins, small screws or other hardware, keys, etc. will degrade the field homogeneity of the magnet should they get inside. It is also possible that the impact of such foreign object could damage the magnet. **Do not drop the magnet.** The permanent magnets are brittle and can easily be permanently damaged. Do not hold magnetic materials near the gap. They will experience large forces that could draw your hand into the gap and cause you injury. Do not bring computer disks near the magnet. The fringe magnetic field is likely to destroy their usefulness.

All permanent magnets are temperature dependent. These magnets are no exceptions. The approximate temperature coefficient for these magnets is:

$\Delta H = 4 \text{ Gauss / } ^\circ\text{C or } 17 \text{ kHz / } ^\circ\text{C for protons}$

It is therefore important that the magnets be kept at a constant temperature. It is usually sufficient to place them on a laboratory bench away from drafts, out of sunlight, and away from strong incandescent lights. Although the magnetic field will drift slowly during a series of experiments, it is easy to tune the spectrometer to the resonant frequency and acquire excellent data before this magnetic field drift disturbs the measurement. It is helpful to pick a good location for the magnet in the laboratory where the temperature is reasonable constant.

B. Case with Power Supply

The case for the modules has a fused and switched power entry unit located on the back right side. The unit uses 2 amp slow blow fuses. A spare set of fuses is stored inside the fuse case. The spectrometer case has a linear power supply enclosed. It has slots for five modules, which connect to the power supply through a back plane of electrical connectors. The modules should be located as follows:

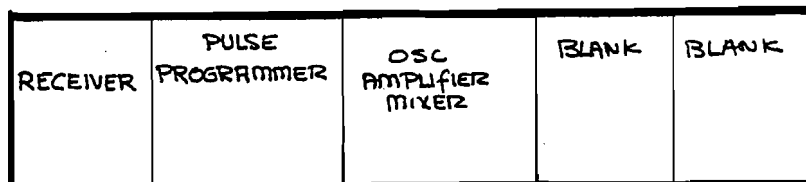

Fig. 2.2

The empty slots will accept future modules to upgrade and enhance this spectrometer. Call us to discuss these additional units. We expect them to be available by January 1995.

C. Pulse Programmer PP-101

The pulse programmer is a complete, self contained, pulse generator which creates the pulse sequences used in all the experiments. The pulses can be varied in width (pulse duration), spacing, number, and repetition time. Pulses are about 4 volt positive pulses with a rise time of about 15 ns. The controls and connectors are described below and pictured in Fig, 3.2

A-width: width of A pulse 1-30 μ s continuously variable

B-width: width of B pulse 1-30 μ s continuously variable

Delay time: 1) with number of B pulses set at 1, this is the time delay between the A and B pulses.

2) with number of B pulses set at 2 or greater, this is the time between A and the first B pulse and one half of the time between the first B pulse and the second B pulse.

3) delay range can be varied from:
10 μ s (which appears as 0.01×10^0 ms)
to
9.99 s (which appears as 9.99×10^3 ms)

Accuracy: 1 pt in 10^6 on all delay times.

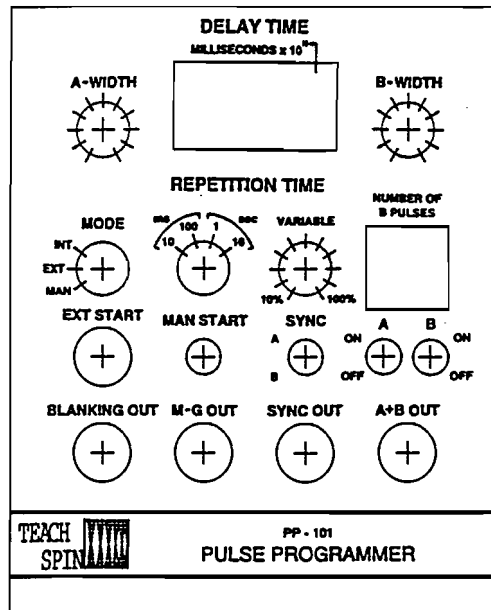

Fig. 3.2 Front panel of pulse programmer

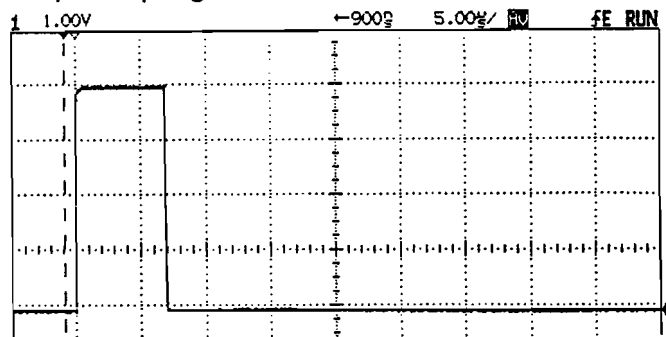

Fig. 4.2 A single A pulse about 7 μ s duration.

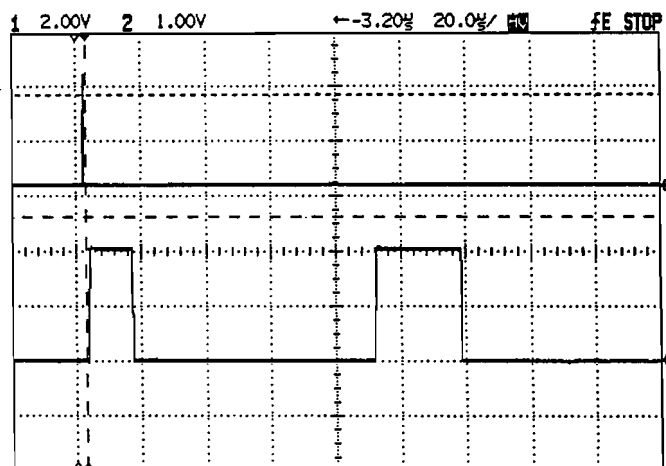

Fig. 5.2 A two pulse sequence where the B pulse (second one on the right) has a 28 μ s duration. The upper trace shows the sync pulse that was used to trigger the oscilloscope on the A pulse.

Mode: This switch selects the signal that starts the pulse sequence. There are three options

Int (Internal): The pulse stream is repeated with a repetition time selected by the two controls at the right of the mode switch.

Ext (External): The pulse stream is repeated at the rising edge of a TTL pulse.

Man (Manual): The pulse stream is repeated every time the manual start button is pushed. This allows the experimenter to choose arbitrarily long repetition times for the experiment.

Repetition Time: four position 10ms, 100 ms, 1s
10 s, variable 10-100% on any of the four position.
Thus for 100 ms and 50%, the repetition time is 50 ms.
The range of repetition times is 10 ms 10% or 1 ms to 10 s
100% or 10 s.

Number of B Pulses: This sets the number of B pulses from 0 to 99

Ext-Start: Rising edge of a TTL pulses will start a single pulse stream.

Man-Start: Manual start button which starts pulse stream on manual mode.

Sync Switch: This switch allows the experimenter to choose which pulse, A or B, will be in time coincides with the output sync pulse. In Fig. 5.2, the upper trace shows the sync pulse occurring at the beginning of the A pulse.

A-switch: turns on or off the A pulse output

B-switch: turns on or off the B pulse output

Blanking out: A blanking pulse used to block the receiver during the rf pulse and thus to improve the receiver recovery time.

M-G out: Meiboom-Gill phase shift pulse, connected to the oscillator, to provide a 90° phase shift after the A pulse.

Sync out: A fast rising positive 4 volt pulse of 200 ns duration used to trigger an oscilloscope or other data recording instrument. Fig. 6.2, top trace show the sync pulse coincident with the beginning of the B pulse (lower trace).

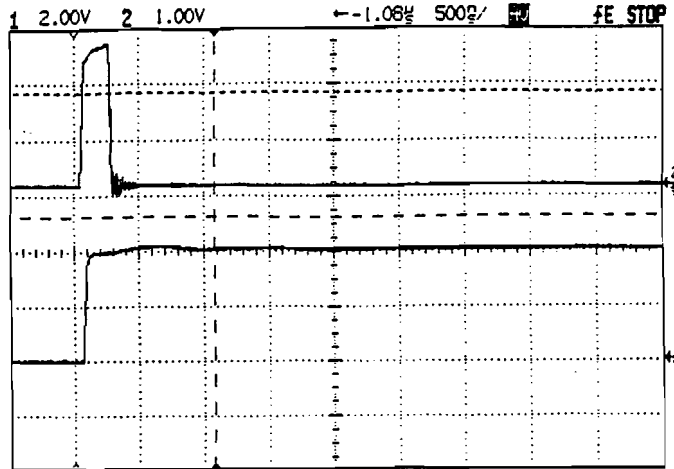

Fig.6.2

A & B OUT: 4 volt positive A & B pulses, shown in Fig.5.2.

D. 15 MHz OSC/AMP/MIXER:

There are three separate functioning units inside this module. A tunable 15 MHz oscillator, an rf power amplifier, and a mixer. The **oscillator** is digitally synthesized and locked to a crystal oscillator so that its stability is better than 1pt in 10^6 over 30 minutes. The frequency in MHz is displayed on a seven digit LED readout at the top center of the instrument (See Fig. 7.2). This radio frequency signal can be extracted as a continuous signal (CW-RF out, switch on) or as rf pulse burst in to the transmitter coil inside the sample probe.

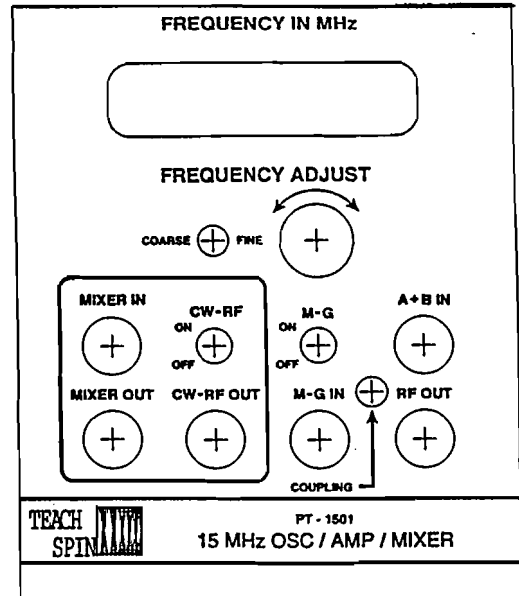

Fig.7.2

The second unit is the **power amplifier**. It amplifies the pulse bursts to produce 12 Gauss rotating radio frequency magnetic fields incident on the sample. It has a peak power output of about 150 watts.

The third unit is the **mixer**. It is a nonlinear device that effectively multiplies the CW rf signal from the oscillator with the rf signals from the precessing nuclear magnetization. The frequency output of the mixer is proportional to the difference frequencies between the two rf signals. If the oscillator is

properly tuned to the resonance, the signal output of the mixer should show no "beats", but if the two rf signals have different frequencies a beat structure will be superimposed on the signal. The beat structure is clearly evident on the upper trace of the signals from a two pulse free induction spin echo signal, shown in Fig. 8.2. The mixer output and the detector output from the receiver module may have identical shape. It is essential, however, to tune the oscillator so as to make these two signals as close as possible and obtain a zero-beat condition. That is the only way you can be sure that the spectrometer is tuned to resonance for the magnetic field imposed.

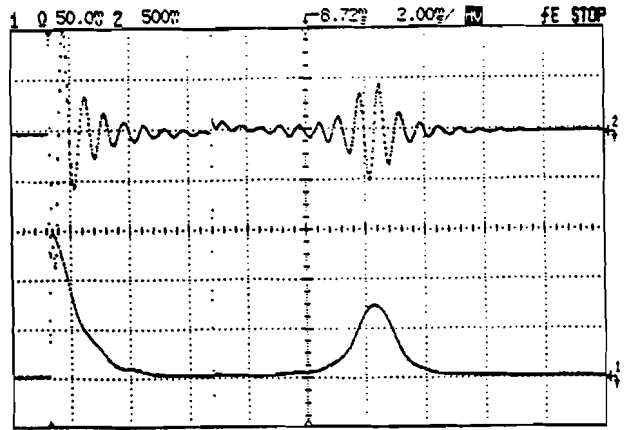

Fig. 8.2

IMPORTANT: DO NOT OPERATE THE POWER AMPLIFIER WITHOUT ATTACHING TNC CABLE FROM SAMPLE PROBE. DO NOT OPERATE THIS UNIT WITH PULSE DUTY CYCLES LARGER THAN 1%. DUTY CYCLES OVER 1% WILL CAUSE OVERHEATING OF THE OUTPUT POWER TRANSISTORS. SUCH OVERHEATING WILL AUTOMATICALLY SHUT DOWN THE AMPLIFIER AND SET OFF A BUZZER ALARM. IT IS NECESSARY TO TURN OFF THE ENTIRE UNIT TO RESET THE INSTRUMENT. POWER WILL AUTOMATICALLY BE SHUT OF TO THE AMPLIFIER IN CASE OF OVERHEATING AND RESET ONLY AFTER THE INSTRUMENT HAS BEEN COMPLETELY SHUT OFF AT THE AC POWER ENTRY.

Frequency in MHz: The LED displays the synthesized oscillator frequency in megahertz (10^6 cycles/second).

Frequency Adjust: this knob changes the frequency of the oscillator. When the switch (at its left) is on *course* control, each "click" changes the frequency by 1,000 Hz, when it is switched to *fine*, each click changes the frequency 10 Hz. The smallest change in this digitally synthesized frequency is 10 Hz.

The Mixer (inside black outline)

Mixer In - rf input signal from receiver, 50 m V rms (max.)

Mixer Out - detected output, proportional to the difference between cw-rf and rf from precessing magnetization. Level, 2 v rms (max.)

bandwidth 500 kHz.

CW-RF switch: on-off switch for cw-rf output.

CW-RF OUT: continuous rf output from oscillator - 13dbm into 50Ω load.

M-G Switch: turns on phase shift of 90° between A and B pulse for multipulsed Meiboom-Gill pulse sequence.

A & B in: input for A & B pulses from pulsed programmer.

RF out: TNC connector output of amplifier to the transmitter coil inside sample probe. Radio frequency power bursts that rotate magnetization of the sample.

Coupling: This adjustment should only be made by the instructor using a small screwdriver. Adjusting the screw inside the module optimizes the power transfer to the transmitter coils in the sample probe. This adjustment has been made of the factory and should not need adjusting under ordinary operating conditions.

E. 15 MHz Receiver

This is a low noise, high gain, 15 MHz receiver designed to recover rapidly from an overload and to amplify the radio frequency induced *EMF* from the precessing magnetization. The input of the receiver is connected directly to a high Q coil wrapped around the sample vials inside the sample probe. The tiny induced voltage from the precessing spins is amplified and detected inside this module. The module provides both the amplified rf signal as well as detected signal. The rf signal can be examined directly on the oscilloscope. For example, Fig. 9.2

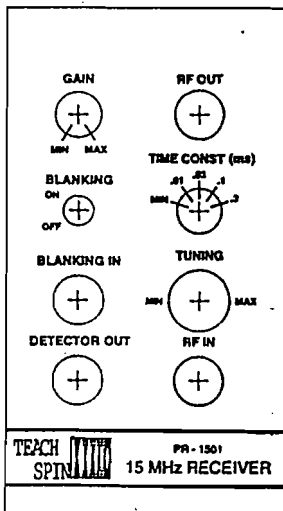
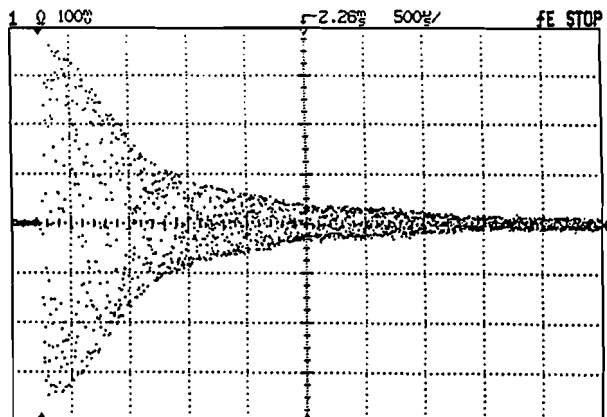

Fig.9.2



shows a free induction decay signal from precessing nuclear magnetization in mineral oil. This data was obtained on the HP 54600A digital oscilloscope. On this instrument, it is not possible to see the individual 15 MHz cycles, but with an analog scope, these cycles can be directly observed. Please note, these are *not* the beat cycles seen in the output of the mixer, but **decaying 15 MHz oscillations of the free induction decay.**

Gain: continuously variable, range 60 dB (typical)

RF out: amplified radio frequency signal from the precessing nuclear magnetization

Blanking: turns blanking pulse on or off

Blanking In: input from blanking pulse, to reduce overload to the receiver during the power rf pulses.

Time Constant: selection switch for RC time constant on the output of the amplitude detector. The longer the time constant, the less noise that appears with the signal. However, the time constant limits the response time of the detector and *may* distort the signal. The longest time constant should be compatible with the fastest part of the changing signal.

Tuning: rotates a variable air capacitor which tunes the first stage of the amplifier. It should be adjusted for maximum signal amplitude of the precessing magnetization.

Detector Out: the output of the amplitude detector to be connected to the vertical scope input.

RF In: To be connected to the receiver coil inside the sample probe. This directs the small signals to the first stage of the amplifier.

Fig. 10.2 shows a two pulse (90° - 180°) free induction decay - spin echo signal as observed from the rf output port (upper trace) and detector output port (lower trace) of the receiver. Again, it is not possible to observe the individual oscillation of the 15 MHz on this trace (with this time scale and the digital scope) but it is clear that the detector output rectifies the

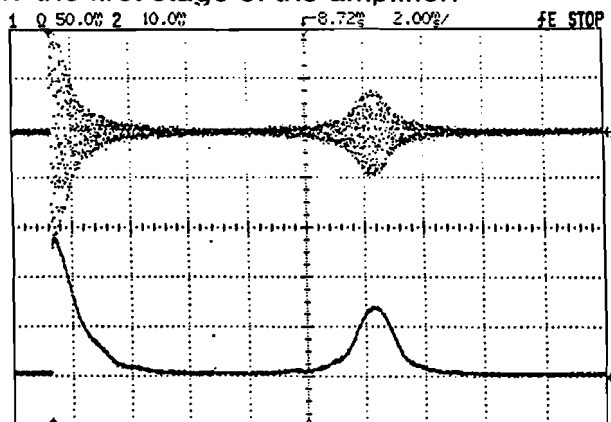

Fig.10.2

signal ("cuts" it in half) and passes only the envelope of the rf signal. It is also important to remember that the precession signal from spin system cannot be observed during the rf pulse from the oscillator /amplifier since these transmitter pulses induce voltages in the receiver coil on the order of 10 volts and the nuclear magnetization creates induced EMF 's of about $10\mu V$; a factor of 10^6 smaller!

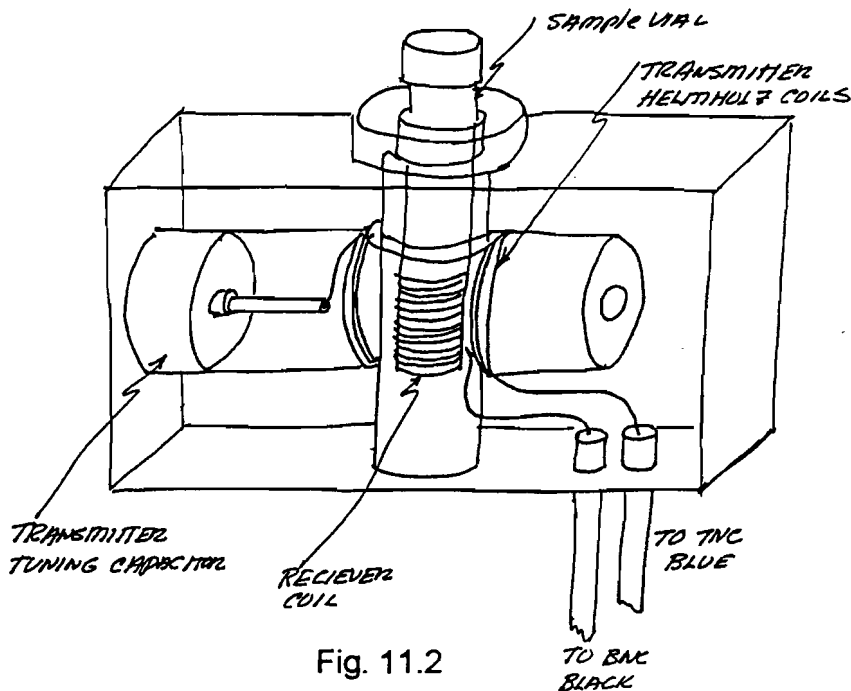

Fig. 11.2

Fig. 11.2 shows an artist sketch of the sample probe. The transmitter coil is wound in a Helmholtz coil configuration so that the axis is perpendicular to the constant magnetic field. The receiver pickup coil is wound in a solenoid configuration tightly around the sample vial. The coil's axis is also perpendicular to the magnetic field. The precessing magnetization induces an EMF in this coil which is subsequently amplified by the circuitry in the receiver. Both coaxial cables for the transmitter and receiver coils are permanently mounted in the sample probe and should not be removed. Caution should be exercised if the sample probe is opened since the wires inside are delicate and easily damaged. Care should be exercised that **no foreign objects, especially magnetic objects are dropped inside the sample probe.** They can seriously degrade or damage the performance of the spectrometer.

G. Auxiliary Components

1. PICKUP PROBE

A single loop of # 32 wire with a diameter of 6mm is used to measure the B_1 of the rotating rf field. This loop is encapsulated with epoxy inside a sample vial and attached to a short coaxial cable. The coaxial cable has a female BNC connector at the other end. To effectively eliminate the effects of the coaxial cable on the pickup signal from the transmitter pulse, a 50 ohm

termination is attached at the pickup loop end as shown in the diagram. Since the single loop has a very low impedance, the signal at the oscilloscope is essentially the same as the signal into an open circuit. Note: the orientation of the pickup loop inside the sample holder is important, since the plane of the loop must be perpendicular the the rf field. (Faraday's Law!)

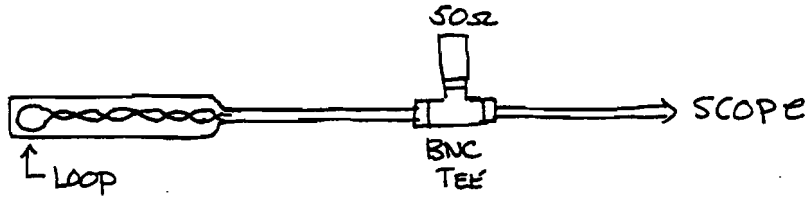

2. DUMMY SIGNAL COIL

A second single loop of # 32 wire in series with a 22k resistor is used to create a "dummy signal". This probe is also placed in the sample holder and located at the proper depth to produce the maximum signal. The loop is also connected to the terminating resistor to eliminate cable effects. This probe is attached to the cw output of the oscillator to create a signal which can be used to tune and calibrate the spectrometer. The connections are shown in the diagram.

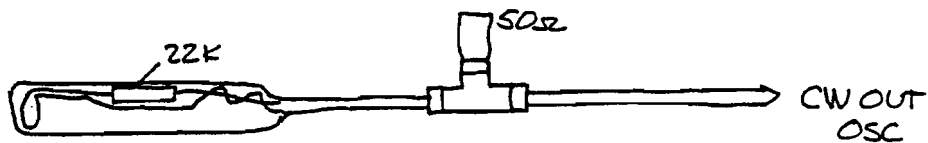

GETTING STARTED

You might be tempted now to put a sample in the probe and try to find a free induction decay or even a spin echo signal right away. Some of you will probably do this, but we recommend a more systematic study of the instrument. In this way you will quickly acquire a clear understanding of the function of each part and develop the facility to manipulate the instrument efficiently to carry out experiments you want to perform.

A. Pulse Programmer

1. Single Pulse

Begin with the pulse programmer and the oscilloscope. The A and B pulses that are used in a typical pulsed experiment have pulse widths ranging from 1 to 35 ms. Let's begin by observing a single A pulse like that shown in Figure 12. The pulse programmer settings are:

A-width: half way
Mode: Int
Repetition time: 10 ms 10%
Sync: A
A: On
B: Off
Sync Out: Connected to ext. sync input to oscilloscope
A & B Out: Connected to channel 1 vertical input of oscilloscope

Your oscilloscope should be set up for external sync pulse trigger on a positive slope; sweep time of 2, 5, or 10 $\mu\text{s}/\text{cm}$, and an input vertical gain of 1 V/cm. Turn the A-width and observe the change in the pulse width. Change the repetition time, notice the changes in the intensity of the scope signal on the analog scope. Switch the mode to Man, and observe the pulse when you press the main start button. Set the oscilloscope time to 1.0 ms/cm and the repetition time to 10 ms and change the variable repetition time from 10% to 100%. What do you observe?

2. The Pulse Sequence

At least a two pulse sequence is needed to observe either a spin echo or to measure the spin lattice relaxation time T_1 . So let's look at a two pulse sequence on the oscilloscope. Settings:

A, B Width: Arbitrary
 Delay Time: 0.10×10^0 (100 μ s)
 Mode: Int
 Repetition time: 100 ms variable 10%
 Number of B Pulses: 01
 Sync: A
 A: on B: on
 Sync Out: To ext. sync input on scope.
 A & B out: Vertical input on scope

The pulse train should appear like Figure 5.2, lower trace, if the time base on the oscilloscope is 20 μ s / cm and the vertical gain is 1 V / cm. Now you should play. Change the A and B width, change delay time, change sync to B (you will now see only the B pulse since the sync pulse is coincident with B), turn A off, B off, change repetition time, and observe what happens. Look at a two pulse train with delay times from 1 to 100 ms (1.00×10^0 to 1.00×10^2)

3. Multiple Pulse Sequence

The Carr-Purcell or Meiboom-Gill pulse train require multiple B pulses. In some cases you may use 20 or more B pulses. To see the pattern of this pulse sequence, we will start with a 3 pulse sequence.

A-width: 20%
 B-width: 40%
 Delay time: 0.10×10^0 (100 μ s)
 Mode: Int
 Repetition Time: 100 ms variable 10%
 Number of B pulses: 02
 Sync A
 A: On B: On
 Oscilloscope Sweep 0.1 ms / cm
 A & B out : Vertical input on scope

Change the number of B pulses from 3 - 10. Note the width of B and the spacing between pulses. Change the mode switch to **man** and press the manual **start** button. Change the delay time to 2.00×10^0 ms and the oscilloscope to 2 ms / cm horizontal sweep. Notice that on this time scale the pulses appear as spikes, and it is difficult to observe any change in the pulse width when the B width is changed over its entire range.

B. Receiver

The receiver is designed to amplify the tiny voltages induced in the receiver coil by the magnetization precessing in the transverse (x-y) plane. The receiver coil is part of a parallel tuned resonant circuit with the tuning capacitor mounted inside the receiver module. It is important to tune this coil to the resonant frequency (the precession frequency) of the spin system in order to achieve optimum signal to noise and maximum gain. Before you tune the receiver to a real magnetic resonance signal, you can tune it to the oscillator frequency (which should be set at the estimated resonance frequency) using a special "dummy signal" probe. This probe is connected to the cw rf oscillator. The loop end is placed inside the sample probe where it induces an *EMF* in the receiver coil like the precessing spins. The "dummy signal" is induced into the receiver with the A or B pulses turned **OFF**. This dummy signal allows you to tune the receiver and observe the rf and detected signals as a function of tuning and gain.

In preparation for a magnetic resonance experiment, the receiver should be tuned to the proton's resonance frequency in your magnet. Note: The strength of the magnetic field is registered on the blue serial label on the back side of the magnet yoke.

C. Spectrometer

Connect the spectrometer modules together using the BNC cables as shown in Fig. 1.3. Please note the special TNC connector (rf out) which connects the power amplifier to the transmitter coils inside the sample probe. Connecting the blanking pulse is optional. There may be experiments that you attempt later where the sample has a very short T_2 and the blanking pulse will be helpful. It is not necessary to use it now. You cannot damage the electronics by making the wrong connections but you can certainly cause yourself grief. Most likely you will not see the signal. Check your connections carefully. Check them against the block diagram, Figure 1.2.

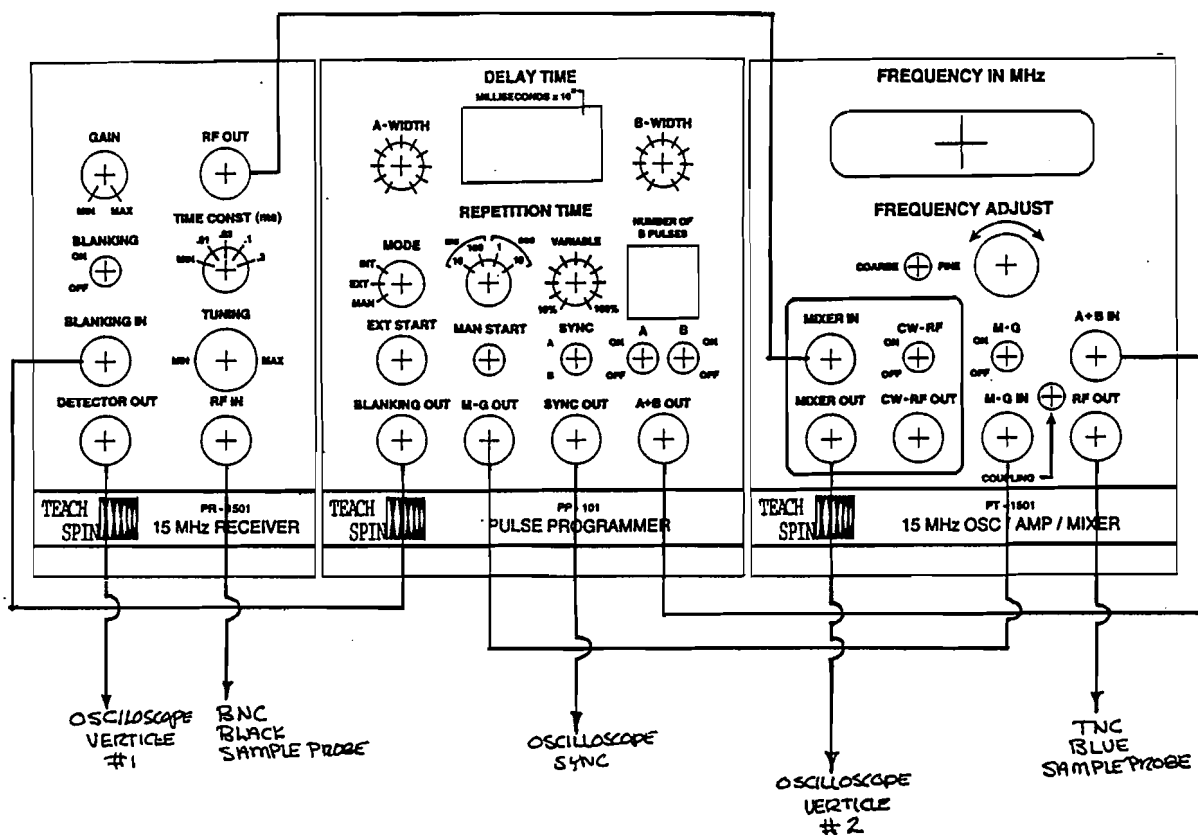

Fig. 1.3

D. Single Pulse NMR Experiment - Free Precession (Induction) Decay

The first pulsed magnetic resonance experiment to attempt requires only a single rf pulse. The signal you are looking for is called by two different but equivalent names, the free precession or free induction decay (FID). The later name is more commonly used. The signal is due to a net magnetization precessing about the applied constant magnetic field B_0 in the transverse plane (x-y). Remember, in **thermal equilibrium there is no transverse magnetization**, since all the nuclear spins are precessing out of phase with each other. The transverse magnetization is clearly **not** in thermal equilibrium.

So we have to create it. We begin by waiting long enough for the thermal equilibrium magnetization to become established in the z-direction. Now we apply a high power rf pulsed magnetic field B_1 to the sample for a time $t_w(90^\circ)$ sufficient to cause a precession of this magnetization 90° in the rotating frame. After the transmitter pulse has been turned off, the thermal equilibrium magnetization is left in the x-y plane where it precesses about the static magnetic field B_0 . The precession signal then decays to zero in a time determined either by the magnet or by the real spin-spin relaxation time T_2 , whichever is shorter. Fig. 9.2 shows the free precession decay of mineral oil, after the 90° pulse.

For the first experiment you want to choose a sample that not only has a large concentration of protons, but also a reasonably short spin-lattice relaxation time, T_1 . Remember, all PNMR experiments begin by assuming a thermal equilibrium magnetization along the z-direction. But this magnetization builds exponentially with a time constant, T_1 . **Each** experiment, that is, **each** pulse sequence, must wait at least $3 T_1$, (preferably 6-10 T_1 's) before repeating the pulse train. For a single pulse experiment that means a repetition time of 6-10 T_1 . If you choose pure water, with $T_1 \approx 3s$, you would have to wait a half a minute between each pulse. Since several adjustments are required to tune this spectrometer, pure water samples can be very time consuming and difficult to work with.

Mineral oil has a T_1 of about 12 ms at room temperature. That means the repetition time can be set 100 ms and the magnetization will be in thermal equilibrium at the start of each pulse sequence (or single pulse in this first experiment). But how do you set the pulse width so as to produce a 90° pulse? You have two options here.

1. Using the special pickup loop placed inside the sample probe, measure the induced **EMF DURING THE TRANSMITTER PULSE** and calculate the rotating rf magnetic field. Using equation 25.1 you can calculate t_w , the width of the pulse necessary to produce the 90° rotation. This measurement is probably only accurate to 25%, and further adjustments on the real signal is still needed.
2. A " 90° pulse", as it is called, produces the maximum amplitude of the free induction decay, since it rotates all of M_z into the x-y plane. But this is only true if the spectrometer is on resonance, so that the effective field in the rotating frame is $B_1 \hat{i}$. To assure yourself you are tuned to resonance, the free induction signal must produce a zero beat with the master oscillator as observed on the output of the mixer. IF the zero beat condition is obtained, then the shortest A-width pulse that produces the maximum amplitude of the free induction decay is a 90° pulse. The setup is:

Sample:	Mineral oil
A-width:	$\approx 20\%$
Mode:	Int
Repetition time:	100 ms, 100%
Number of B Pulses:	0
Sync A	
A:	on
B:	off
Tune frequency adjust for zero-beat mixer output	
Tune receiver input for maximum signal	
Time constant:	.01
Gain:	30%

Important Note: Do not fill vial with sample material. The standard samples which are approximately cubical (about 5 mm in height) are the appropriate size. This size sample fills the receiver coil and the pulsed magnetic field is uniform over this volume. Larger samples will not experience uniform rf magnetic. In that case all the spins are not rotated the same amount during the pulse. Such sample can cause serious errors in the measurements of T_1 and T_2 . It is important to adjust the sample to the proper depth inside the probe. A rubber o-ring, placed on the sample vial, acts as an adjustable stop and allows the experimenter to place the sample in the center of the rf field and receiver coil, see Fig. 2.3.

E. Magnetic field contours

After you have found a free induction decay signal and set up the spectrometer for a 90° pulse, it is time to examine the field contour of the magnet and find the place in the gap where the magnetic field has the best uniformity; the "sweet spot". The two controls on the sample carriage allow you to move the sample in the x-y plane. The magnetic field at the sample uniquely determines the frequency of the free-induction decay signal. This frequency can be measured directly by beating it against the master oscillator's frequency using the mixer.

Plot the magnetic field as a function of position in the x-y plane

Caution: The magnetic field in the gap changes with temperature. To create an accurate field plot, it is essential to make these measurements quickly in a well regulated temperature environment.

The field gradients over the sample can be estimated from the decay of the free induction signal. For mineral oil, the real T_2 is much longer than the free induction decay time.

F. Rotating Coordinate Systems (Optional Experiments)

What happens to our spin systems when the spectrometer is *not* tuned to resonance? Can a signal be observed? What is a 90° , a 180° pulse? These questions and more can be answered by a series of easy experiments that give somewhat puzzling results. These experiments can help you understand rotating coordinate systems and PNMR **off resonance**. They are

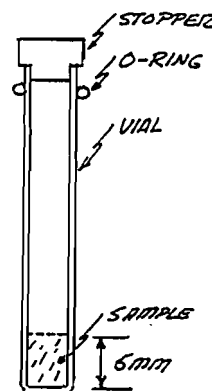

Fig. 2.3

all single pulse experiments that use mineral oil or some other equivalent sample with $T_1 < 50$ ms.

Tune the spectrometer to resonance using a single 90° pulse and observe the zero beat of the free induction decay. Put both detected signals on the oscilloscope display using both input channels. Now change the frequency of the oscillator, first going to higher frequency (about .7 MHz upfield) and later to lower frequencies. Note the free induction decay signals. Change the frequency until no signal appears (but make sure no signal reappears when the frequency is further changed). It may be necessary to slightly tune the receiver to see the signal. Adjust the pulse width at several frequencies **off resonance**. What do you observe? Is it possible to create a 360° pulse off resonance? How do you know it is 360° ?

Explain what you observed. Draw diagrams of the effective fields in the rotating frame **off** resonance. These will help you understand your observations. Although your explanations should be mostly qualitative, it helps to record some numerical data, such as signal amplitude and frequency.

G. Spin Lattice Relaxation Time, T_1 .

The time constant that characterizes the exponential growth of the magnetization towards thermal equilibrium in a static magnetic field, T_1 , is one of the most important parameters to measure and understand in magnetic resonance. With the PS1-A, this constant can be measured directly and very accurately. It also can be quickly estimated. Let's start with an order of magnitude estimate of the time constant using the standard mineral oil sample.

1. Adjust the spectrometer to resonance for a single pulse free induction decay signal.
2. Change the Repetition time, reducing the FID until the maximum amplitude of the FID is reduced to about 1/3 of its largest value.

The order of magnitude of T_1 is the repetition time that was established in step 2. Setting the repetition time equal to the spin lattice relaxation time does not allow the magnetization to return to its thermal equilibrium value before the next 90° pulse. Thus, the maximum amplitude of the free induction decay signal is reduced to about $1/e$ of its largest value. Such a quick measurement is useful, since it gives you a good idea of the time constant you are trying to measure and allow you to set up the experiment correctly the first time.

1. Two Pulse - Zero Crossing

A two pulse sequence can be used to obtain a two significant figure determination of T_1 . The pulse sequence is:

$180^\circ - \tau$ (variable) -90° free induction decay

The first pulse (180°) inverts the thermal equilibrium magnetization, that is ; $M_z \rightarrow -M_z$. Then the spectrometer waits a time τ before a second pulse rotates the magnetization that exists at this later time by 90° . How can this pulse sequence be used to measure T_1 ?

After the first pulse inverts the thermal equilibrium magnetization, the net magnetization is $-M_z$. This is *not* a thermal equilibrium situation. In time the magnetization will return to $+M_z$. Fig. 3.3 shows a pictorial representation of the process. The magnetization grows exponentially towards its thermal equilibrium value.

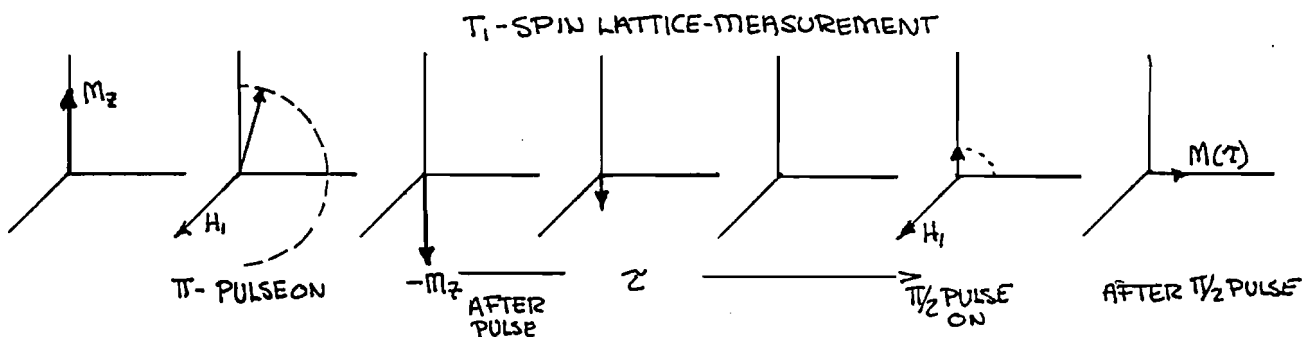

But the spectrometer **cannot detect** magnetization along the z-axis. It only measures precessing **net** magnetization in the x-y plane. That's where the second pulse plays its part. This pulse rotates **any net** magnetization in the z-direction into the x-y plane where the magnetization can produce a measurable signal. In fact, the initial amplitude of the free induction decay following the 90° pulse is proportional to the net magnetization along the z-axis ($M_z(\tau)$), **just before the pulse**. You should be able to work out the algebraic expression for T_1 in terms of the particular time τ_0 where the magnetization $M_z(\tau_0) = 0$, the "so called" zero crossing point. They are related by a simple constant.

2. A more accurate method to determine T_1 uses the same pulse sequence as we just described but plots $M(\tau)$ as a function of τ . Since it is an exponential process, the plot is logarithmic. But be careful! There are some subtleties to watch out for. Hint: It is essential to measure $M_z(\infty)$, that is the

thermal equilibrium magnetization along the z-direction, very accurately. Why? The analysis of these experiments is left to the student.

Note: A 180° pulse is characterized by a pulse approximately twice the length of the 90° pulse, which has no signal (free induction decay) following it. A true 180° pulse should leave no magnetization in the x-y plane after the pulse.

H. Spin-Spin Relaxation Time - T_2

The spin-spin relaxation time, T_2 , is the time constant characteristic of the decay of the transverse magnetization of the system. Since the transverse magnetization does not exist in thermal equilibrium a 90° pulse is needed to create it. The decay of the free induction signal following this pulse would give us T_2 if the sample was in a perfectly uniform magnetic field. As good as the PS1-A's magnet is, it is not perfect. If the sample's T_2 is longer than a few milliseconds, a spin-echo experiment is needed to extract the real T_2 . For $T_2 < 0.3$ ms, the free induction decay time constant is a good estimate of the real T_2 .

1. Two Pulse-Spin Echo

We have already discussed the way a 180° pulse following a 90° pulse reverses the x-y magnetization and causes a rephasing of the spins at a later time. This rephasing of the spins gives rise to a spin-echo signal that can be used to measure the "real" T_2 . The pulse sequence is:

$$90^\circ \text{ -- } \tau \text{ -- } 180^\circ \text{ -- } \tau \text{ -- } \text{echo}(2\tau)$$

A plot of the echo amplitude as a function of the delay time 2τ will give the spin-spin relaxation time T_2 . The echo amplitude decays because of stochastic processes among the spins, not because of inhomogeneity in the magnetic field.

2. Multiple Pulse - Multiple Spin Echo Sequences.

A. Carr-Purcell

The two pulse system will give accurate results for liquids when the self diffusion times of the spin through the magnetic field gradients is slow compared to T_2 . This is not often the case for common liquids in this magnet. Carr and Purcell devised a multiple pulse sequence which reduces the effect of diffusion on the measurement of T_2 . In the multiple pulse sequence a series of 180° pulses spaced a time τ apart is applied as:

$$90^\circ - \tau/2 - 180^\circ - \tau - 180^\circ - \tau - 180^\circ - \dots$$

creating a series of echoes equally spaced between the 180° pulses. The exponential decay of the maximum height of the echo envelope can be used to calculate the spin-spin relaxation time. The spacing between the 180° pulses τ should be short compared to the time of self diffusion of the spins through the field gradients. If that is the case, this sequence significantly reduces the effects of diffusion on the measurement of T_2 .

B. Meiboom-Gill

There is a serious practical problem with the Carr-Purcell pulse sequence. In any real experiment with real apparatus, it is not possible to adjust the pulse width and the frequency to produce an exact 180° pulse. If, for example, the spectrometer was producing 183° pulses, by the time the 20th pulse was turned on, the spectrometer would have accumulated a rotational error of 60° , a sizable error. This error can be shown to effect the measurement of T_2 . It gives values that are too small.

Meiboom and Gill devised a clever way to reduce this accumulated rotation error. Their pulse sequence provides a **phase shift** of 90° between the 90° and the 180° pulses, which cancels the error to first order. The M-G pulse train gives more accurate measurements of T_2 . All your final data on T_2 should be made with the Meiboom-Gill pulse on. The only reason it is not permanently built into the instrument is to show you the difference in the echo train with and without this phase shift.

C. Self Diffusion

Carr and Purcell showed that self diffusion leads to the decay of the echo amplitude given by the expression

$$M(\tau) = M_0 e^{-\gamma^2 \left(\frac{\partial H}{\partial z}\right)^2 \frac{D\tau^3}{12}}$$

for the case where the field gradient $\frac{\partial H}{\partial z}$ is in the z-direction.

It is possible to use this pulse sequence to measure D , the diffusion constant, if the sample is placed in a know field gradient. This is an advanced experiment to be attempted only after mastering the basic measurements of T_1 and T_2 .

EXPERIMENTS

This brief section will suggest a series of experiments that can be carried out using your spectrometer. This is by no means an encyclopedic list; rather a collection of experiments that will provide a challenging experience to undergraduate and graduate students. They all require reading of the literature for a thorough physical explanation.

A. T_1 and T_2 in water doped with paramagnetic ions.

Paramagnetic ions, with their large electronic magnetic moment, profoundly effect relaxation times of the protons in water. The materials are easy to obtain and reasonably safe to handle. Paramagnetic ions that dissolve in water are: CuSO_4 and $\text{Fe}(\text{NO}_3)_3$. Effects can be measured over a wide range of concentrations.

B. T_1 and T_2 in Glycerin and water mixtures

Glycerin and water mix in any ratio. The motion of the protons in glycerin is significantly changed by the change of the liquid viscosity with the addition of water. The relaxation times can be correlated with the viscosity of the liquid, as well as the water concentration.

C. T_1 and T_2 in mineral oil with solvents.

The relaxation times of protons in mineral oil diluted with organic solvents shows effects of diffusion and correlation's times.

D. T_1 and T_2 in Petroleum Jelly

Vaseline is not a solid. The two relaxation times indicate fast molecular motion which is characteristic of a liquid. Sample can be heated and T_1 as well as T_2 can be estimated as the sample cools to room temperature. Other organic greases with sufficient proton concentrations can also be studied.

E. Biological Materials

Most biological materials have proton, usually in water molecules. Measurements of T_1 and T_2 in biological materials gives detailed information about the local environment of these water molecules. This area of exploration is wide open. This might be an area appropriate for an undergraduate research participation project.

F. Natural Products

All types of natural products contain water which can be studied by this spectrometer. Use your imagination.

G. Other Magnetic Nuclei

Should you have your own electromagnetic with sufficient stability, homogeneity, and field, you can use the PS1-A to study PNMR in other nuclei. The easiest is Fluorine, which requires a 6% higher field than our magnet, but the alkali metal (Na, K, Li, Rb) provide interesting systems. Other nuclei might also be attempted.

SPECIFICATIONS PS1-B

PULSED NUCLEAR MAGNETIC RESONANCE SPECTROMETER

MAGNET - FIELD STRENGTH IN GAP 3500 GAUSS (NOMINAL)
GAP 1.1 inches
UNIFORMITY .01% over 1cm³ volume
CARRIAGE Horizontal - Vertical Motion ± 2 cm
TEMPERATURE COEFFICIENT 4 Gauss/^oc
WEIGHT 42 LBS.
LUBRICATE BEARINGS WITH WD-40

CASE WITH POWER SUPPLY

POWER SUPPLY - TRIPLE OUTPUT
+5 volts @ 6A
+15 volts @ 1A
-15 volts @ 1A
Line regulation $\pm .05\%$ for 10% line change
Ripple 2 mv rms maximum
Load regulation $\pm .05\%$ for 50% load change
Two empty slots for additional modules
WEIGHT 15 LBS.

PULSE PROGRAMMER PP-101

A-PULSE 1-30 ms 4 volt positive
B-PULSE 1-30 ms 4 volt positive
Delay Time 10 ms (0.01×10^0) - 9.99 s (9.99×10^3)
MODE: Internal, External Pulse, Manual
REPETITION TIME: 1 ms to 10 s
Meiboom - Gill Phase shift pulse
Scope Synchronizing Pulse either at A or B
NUMBER OF B PULSES: 0-99

OSCILLATOR / AMPLIFIER / MIXER PT-1501
15 MHz DIGITALLY SYNTHESIZED OSCILLATOR
FREQUENCY RESOLUTION 10 Hz
FREQUENCY ACCURACY: .005%
CW-RF OUTPUT LEVEL - 13 db
PEAK OUTPUT POWER 150 watts (nominal)
MIXER INPUT LEVEL: 50 mv rms (max)
MIXER OUTPUT LEVEL: 2 v rms (max)
MIXER BANDWIDTH: 500 KHz

RECEIVER PR 1501

CENTER FREQUENCY: 15 MHz (nominal) TUNABLE

BANDWIDTH 200 KHz (3db)

SENSITIVITY $8\mu V$ for full scale output

OUTPUT VOLTAGE / RANGE: 0-10 volts

GAIN RANGE: 60db (typical)

EQUIVALENT NOISE VOLTAGE: 1.5 mV rms

RF OUTPUT LEVEL: 50 mV for full scale signal

TIME CONSTANTS: .01, .03, .1, .3 ms

SAMPLE PROBE

TRANSMITTER COILS IN HELMHOLTZ CONFIGURATION

12 GAUSS ROTATING FIELD AT SAMPLE

RECEIVER COIL

SPECIAL CABLES FOR TRANSMITTER AND RECEIVER

SAMPLE STORAGE CASE

WITH 25 VIALS AND 5 O-RINGS

DUMMY SIGNAL AND TRANSMITTER PROBES.

TeachSpin Inc.

WARRANTY

TeachSpin is proud of the quality and workmanship of its teaching apparatus. We offer a warranty which is unique in the industry because we are confident of the reliability of our instruments.

The PS1-B is warranted for a period of two (2) years from the date of purchase.

We will pay for all labor and parts to repair the instrument to new working specification due to defects in components or workmanship or ordinary use.

Should an electronic component malfunction, **TeachSpin** will ship you within two day a replacement component at **no charge**. **TeachSpin** will accept phone or fax requests for such replacement components. You are responsible to ship to **TeachSpin** the malfunctioning component, fully insured, within a period of three (3) weeks. Failure to do so will result in charging you full retail price for the replacement module. Your defective module will be repaired and returned to you at no charge. You are obligated to return, fully insured, the replacement module originally sent by **TeachSpin**. This two day replacement program assures your students that they can finish the experiments assigned without significant interruption. This warranty is void under the following circumstances:

- a) The instrument has been dropped, damaged, mutilated.
- b) Repaired or attempted repairs not authorized by **TeachSpin**.
- c) Instrument subjected to high voltages, plugged into 210 volts AC or otherwise electrically abused.
- d) Magnet dropped or damaged by impact of magnetic materials or extreme heat.

Do not attempt to repair this instrument while under warranty.

TeachSpin makes no expressed warranty other than the warranty set forth herein, and all implied warranties are excluded.

TeachSpin's liability for any defective product is limited to the repair or replacement of the product at our option. **TeachSpin** shall not be liable for:

1. Damage to other properties caused by any defects, for damages caused by inconvenience, loss of use of the product, commercial loss, or loss of teaching time.
2. Any other damages, whether incidental, consequential or otherwise.

**45 Penhurst Park
Buffalo, NY 14222-1013
1-800-819-3056**

TEACHSPIN, INC.
PULSED NUCLEAR MAGNETIC RESONANCE SPECTROMETER
PS1-B
PACKING LIST

Date: 1-12-98
Serial #: 135
P. O. #: 00344100

Purchased by: University of Tennessee
Faculty Name: Dr. James Parks

- ✓ MAGNET WITH SAMPLE HEAD M1501.....
- ✓ ELECTRONICS CASE WITH POWER SUPPLY PS1501.....
- ✓ RECEIVER PR1501.....
- ✓ PULSE PROGRAMMER PP101.....
- ✓ 15MHz OSC/AMP/MIXER PT1501.....
- ✓ BLANK FRONT PANELS (2).....
- ✓ AC POWER CORD.....
- ✓ 3 FT BNC CABLES (3).....
- ✓ 1 FT BNC CABLES (4).....
- ✓ 50 SAMPLE VIALS IN CASE (# of Sets 1).....
- ✓ RF PICKUP AND DUMMY SIGNAL PROBES.....
- BNC TEE AND 50 Ohm TERMINATION.....
- VIAL CAPS (50).....
- O-RINGS (5).....
- SPECTROL ALIGNMENT TOOL.....
- ✓ INSTRUCTION MANUAL.....

PACKED BY: JR

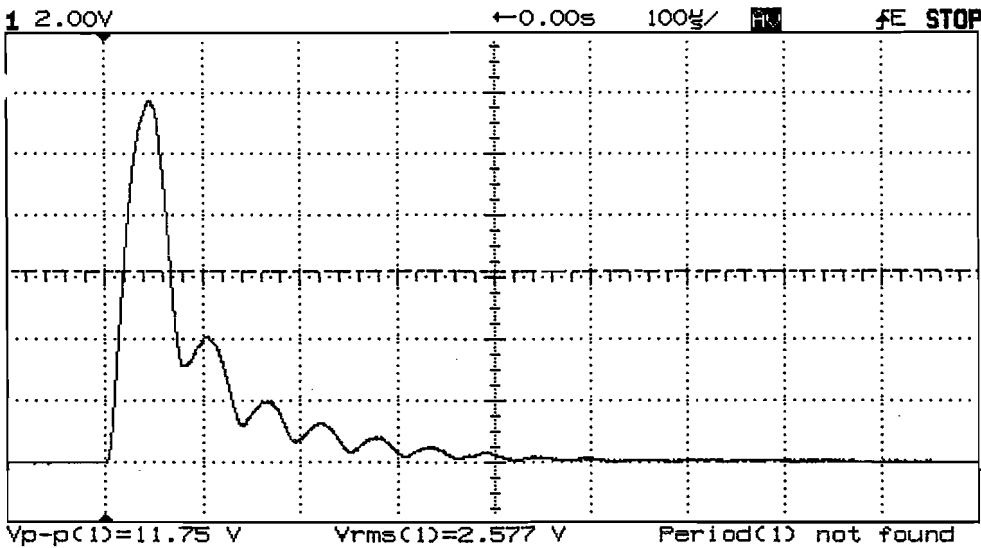

SERIAL 135
 CENTER FIELD
 FREQ 15.20702 MHz
 DEC 13, 1997

	State	Volts/Div	Position	Cplg	BW Lim	Inv	Probe
Chan 1	On	2.000 V	-6.250 V	DC	Off	Off	1:1
Chan 2	Off	50.00 V	162.5 V	DC	Off	Off	10:1

	Mode	Main Time/Div	Main Delay	Time Ref	Delayed Time/Div	Delayed Delay
Horizontal	Normal	100.0us/	0.000 s	Left	-----	-----

Trigger Mode	Source	Level	Holdoff	Slope	Couplg	Reject	NoiseRej
Normal	Normal	250.0mV	388.2us	Pos	DC	Off	Off

Display Mode: Average # Average: 8

Cursors: t1=4.540ms t2=9.180ms V1(1)=6.437 V V2(1)=6.437 V

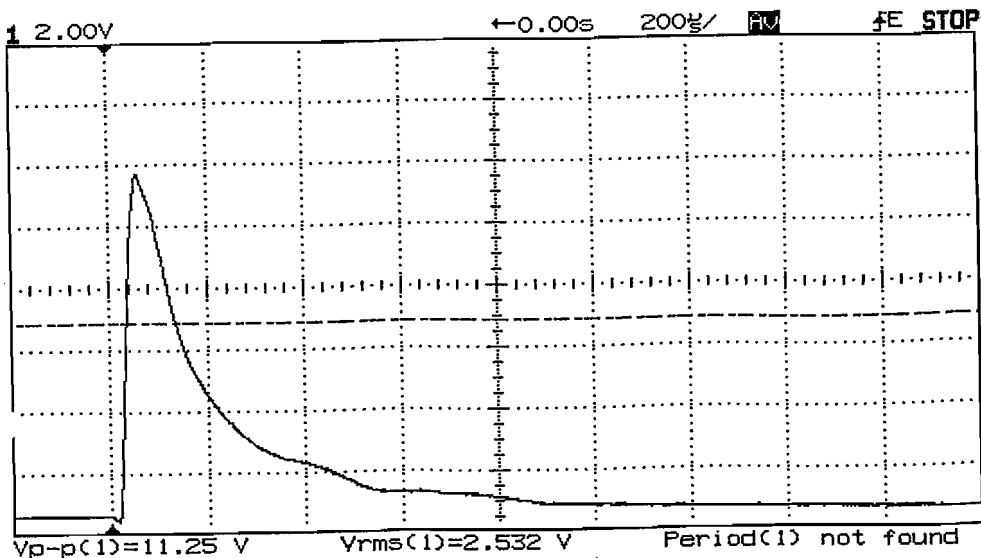

SERIAL 135 (+2.2cm)
 SWEET SPOT (Rot 9.5)
 FREQ 15.25002 MHz
 MINERAL OIL
 DEC 13, 1997 JFR

TEACHSPIN, INC.
PULSED NUCLEAR MAGNETIC RESONANCE SPECTROMETER
PS1-B
PACKING LIST

Date: 1-12-98
Serial #: 135
P. O. #: 00344-1000

Purchased by: University of Tennessee
Faculty Name: Dr. James Parks

- ✓ MAGNET WITH SAMPLE HEAD M1501.....
- ✓ ELECTRONICS CASE WITH POWER SUPPLY PS1501.....
- ✓ RECEIVER PR1501.....
- ✓ PULSE PROGRAMMER PP101.....
- ✓ 15MHz OSC/AMP/MIXER PT1501.....
- ✓ BLANK FRONT PANELS (2).....
- ✓ AC POWER CORD.....
- ✓ 3 FT BNC CABLES (3).....
- ✓ 1 FT BNC CABLES (4).....
- ✓ 50 SAMPLE VIALS IN CASE (# of Sets 1).....
- RF PICKUP AND DUMMY SIGNAL PROBES.....
- BNC TEE AND 50 Ohm TERMINATION.....
- VIAL CAPS (50).....
- O-RINGS (5).....
- SPECTROL ALIGNMENT TOOL.....
- ✓ INSTRUCTION MANUAL.....

PACKED BY: JR

Procedure for Teachspin PNMR

Make connections as shown in figure 1.3 pg. 28 in Teachspin manual.
Allow unit to operate at least 20 min. prior to any measurement or tuning.

Initial Switch Conditions

Gain: 40%
Blanking: ON
Time Constant: 0.1
Mode: INT
Rep Time: 100ms
Variable: 100%
Number of B pulses: 1
CW-RF: OFF
M-G: OFF

I. Tuning

Adjust Receiver tuning knob until Channel 1/Detector Out A-pulse signal is at a maximum.

II. Creating a 90° pulse¹ for pulse A or pulse B

Adjust width control from zero until Channel 1/Detector Out voltage level goes to minimum and then to a maximum.

III. Creating a 180° pulse² for pulse A or pulse B

Adjust width control from zero until Channel 1/Detector Out voltage level goes to minimum, to maximum, and back to minimum.

IV. Finding Resonate Frequency

Turn on pulse A.
Create a 90° pulse.
Turn on CW-RF.
Observe Channel 2/Mixer Out Signal.
Adjust Frequency until beats smooth out.
Turn off CW-RF

V. Measuring T_1 ($180^\circ - \tau - 90^\circ$) Spin-Lattice Relaxation³

Create pulse sequence (A pulse - delay time - B pulse).
Measure voltage of pulse B as a function of τ from 1 to 100ms in increments of three.

Enter data into excel (voltage vs. τ).
From this data create graph similar to Fig 2.1 pg. 4.
From this create graph of $-\ln(1 - [\mu/\mu_0]/2)$ vs. τ .
The inverse of the slope of this line is time T_1 .

VI. Measuring T_2 ($90^\circ - \tau - 180^\circ - \tau$ - echo) Spin-Spin Relaxation⁴

Create pulse sequence (A pulse - delay time - B pulse).

Measure voltage of echo signal (follows A pulse by time 2τ) as a function of the position of the echo (2τ) from 0 to 50ms in increments of two.

Enter data into excel (voltage vs. 2τ).

From this data create graph of $(-1) \cdot \ln(\text{voltage})$ vs. 2τ .

The inverse of the slope of this line is time T_2 .

1. A 90° pulse creates a $\frac{1}{4}$ dipole rotation from the yz plane into the y direction.
2. A 180° pulse creates a $\frac{1}{2}$ dipole rotation from the yz plane into the $-z$ direction.
3. Spin-lattice relaxation (T_1) is a measure of the interactions between a spin system and the lattice in which it resides.
4. Spin-spin relaxation (T_2) is a measure of the interactions between spins within a spin system. Instead of transferring energy out of the system, as is the case with spin-lattice interactions, spin-spin interactions induce a loss of coherence.